

Chiral Structure of Modular Invariants for Subfactors

JENS BÖCKENHAUER and DAVID E. EVANS

School of Mathematics

University of Wales, Cardiff

PO Box 926, Senghennydd Road

Cardiff CF2 4YH, Wales, U.K.

e-mail: BockenhauerJM@cf.ac.uk, EvansDE@cf.ac.uk

YASUYUKI KAWAHIGASHI

Department of Mathematical Sciences

University of Tokyo, Komaba, Tokyo, 153-8914, JAPAN

e-mail: yasuyuki@ms.u-tokyo.ac.jp

October 13, 1999

Abstract

In this paper we further analyze modular invariants for subfactors, in particular the structure of the chiral induced systems of M - M morphisms. The relative braiding between the chiral systems restricts to a proper braiding on their “ambichiral” intersection, and we show that the ambichiral braiding is non-degenerate if the original braiding of the N - N morphisms is. Moreover, in this case the dimensions of the irreducible representations of the chiral fusion rule algebras are given by the chiral branching coefficients which describe the ambichiral contribution in the irreducible decomposition of α -induced sectors. We show that modular invariants come along naturally with several non-negative integer valued matrix representations of the original N - N Verlinde fusion rule algebra, and we completely determine their decomposition into its characters. Finally the theory is illustrated by various examples, including the treatment of all $SU(2)_k$ modular invariants.

Contents

1	Introduction	2
2	Preliminaries	6
3	Chiral analysis	11
3.1	Chiral horizontal projectors and chiral global indices	11
3.2	Chiral branching coefficients	13
3.3	Chiral vertical algebras	14
3.4	Chiral representations	22
4	Chiral structure of the center \mathcal{Z}_h	25
4.1	Non-degeneracy of the ambichiral braiding	25
4.2	Chiral matrix units	28
4.3	Representations of fusion rules and exponents	35
5	The A-D-E classification of $SU(2)$ modular invariants	38
5.1	The local inclusions: A_ℓ , $D_{2\ell}$, E_6 and E_8	39
5.2	The non-local simple current extensions: $D_{2\ell+1}$	39
5.3	E_7	41
5.4	A-D-E and representations of the Verlinde fusion rules	43
6	More examples	46
6.1	Conformal inclusions of $SU(3)$	46
6.2	Trivial invariants from non-trivial inclusions and degenerate braidings	47
A	The dual canonical endomorphism for E_7	49

1 Introduction

An important step towards complete classification of rational conformal field theory would be an exhaustive list of all modular invariant partition functions of WZW models based on simple Lie groups G . In such models one deals with a chiral algebra which is given by a semi-direct sum of the affine Lie algebra of G and the associated Virasoro algebra arising from the Sugawara construction. Fixing the level $k = 1, 2, \dots$, which specifies the multiplier of the central extension, the chiral algebra possesses a certain finite spectrum of representations acting on (pre-) Hilbert spaces \mathcal{H}_λ , labelled by “admissible weights” λ . The characters

$$\chi_\lambda(\tau; z_1, z_2, \dots, z_\ell; u) = e^{2\pi i k u} \operatorname{tr}_{\mathcal{H}_\lambda} (e^{2\pi i \tau (L_0 - c/24)} e^{2\pi i (z_1 H_1 + z_2 H_2 + \dots + z_\ell H_\ell)}),$$

with $\operatorname{Im}(\tau) > 0$, L_0 being the conformal Hamiltonian, c the central charge and H_r , $r = 1, 2, \dots, \ell = \operatorname{rank}(G)$, Cartan subalgebra generators, transform unitarily under

the action of the (double cover of the) modular group, defined by re-substituting the arguments as

$$(\tau; \vec{z}; u) \longmapsto g(\tau; \vec{z}; u) = \left(\frac{a\tau + b}{c\tau + d}; \frac{\vec{z}}{c\tau + d}; u - \frac{c(z_1^2 + z_2^2 + \dots + z_\ell^2)}{2(c\tau + d)} \right)$$

for $g = \begin{pmatrix} a & b \\ c & d \end{pmatrix} \in SL(2; \mathbb{Z})$, see e.g. [21]. A modular invariant partition function is then a sesqui-linear expression $Z = \sum_{\lambda, \mu} Z_{\lambda, \mu} \chi_\lambda \chi_\mu^*$ which is invariant under the $SL(2; \mathbb{Z})$ action, $Z(g(\tau; \vec{z}; u)) = Z(\tau; \vec{z}; u)$, and subject to

$$Z_{\lambda, \mu} = 0, 1, 2, \dots, \quad Z_{0,0} = 1. \quad (1)$$

Here the label “0” refers to the “vacuum” representation, and the condition $Z_{0,0} = 1$ reflects the physical concept of uniqueness of the vacuum state. For the canonical generators $\mathcal{S} = \begin{pmatrix} 0 & -1 \\ 1 & 0 \end{pmatrix}$ and $\mathcal{T} = \begin{pmatrix} 1 & 1 \\ 0 & 1 \end{pmatrix}$ of $SL(2; \mathbb{Z})$ we obtain the unitary Kac-Peterson matrices $S = [S_{\lambda, \mu}]$ and $T = [T_{\lambda, \mu}]$ transforming the characters, where T is diagonal and S is symmetric as well as $S_{\lambda,0} \geq S_{0,0} > 0$. Then the classification of modular invariants can be rephrased like this: Find all the matrices Z subject to the conditions in Eq. (1) and commuting with S and T . This problem turns out to be a rather difficult one; a complete list is known for all simple Lie groups at low levels, however, a list covering all levels is known to be complete only for Lie groups $SU(2)$ and $SU(3)$.

Let us consider the $SU(2)$ case. For $SU(2)$ at level k , the admissible weights are just spins $\lambda = 0, 1, 2, \dots, k$. The Kac-Peterson matrices are given explicitly as

$$S_{\lambda, \mu} = \sqrt{\frac{2}{k+2}} \sin \left(\frac{\pi(\lambda+1)(\mu+1)}{k+2} \right), \quad T_{\lambda, \mu} = \delta_{\lambda, \mu} \exp \left(\frac{\pi i(\lambda+1)^2}{2k+4} - \frac{\pi i}{4} \right),$$

with $\lambda, \mu = 0, 1, \dots, k$. A list of $SU(2)$ modular invariants was given in [5] and proven to be complete in [6, 22], the celebrated A-D-E classification of $SU(2)$ modular invariants. The A-D-E pattern arises as follows. The eigenvalues of the (adjacency matrices of the) A-D-E Dynkin diagrams are all of the form $2 \cos(m\pi/h)$ with $h = 3, 4, \dots$ being the (dual) Coxeter number and m running over a subset of $\{1, 2, \dots, h-1\}$, the Coxeter exponents of the diagram. The bijection between the modular invariants Z in the list of [5] and Dynkin diagrams is then such that the diagonal entries $Z_{\lambda, \lambda}$ are given exactly by the multiplicity of the eigenvalue $2 \cos(\pi(\lambda+1)/(k+2))$ of one of the A-D-E Dynkin diagrams with Coxeter number $h = k+2$. In particular, the trivial modular invariants, $Z_{\lambda, \mu} = \delta_{\lambda, \mu}$, correspond to the diagrams A_{k+1} . Note that the adjacency matrix of the A_{k+1} diagram is given by the level k fusion matrix N_1 of the spin $\lambda = 1$ representation. Here $N_\lambda = [N_{\lambda, \mu}^\nu]$, and the (non-negative integer valued) fusion rules $N_{\lambda, \mu}^\nu$ are generically (e.g. for all $SU(n)$) given by the Verlinde formula

$$N_{\lambda, \mu}^\nu = \sum_\rho \frac{S_{\rho, \lambda} S_{\rho, \mu}}{S_{\rho, 0}} S_{\rho, \nu}^*. \quad (2)$$

As we have $N_\lambda N_\mu = \sum_\nu N_{\lambda, \mu}^\nu N_\nu$, we may interpret the A_{k+1} matrix as the spin one representation matrix in the regular representation of the fusion rules. The meaning

of the D and E diagrams, however, remained obscure, and this has been regarded as a “mystery of the A-D-E classification” [18]. In fact, the adjacency matrices of the D-E diagrams turned out to be only the spin $\lambda = 1$ matrices G_1 of a whole family of non-negative integer valued matrices G_λ providing a representation of the original $SU(2)_k$ fusion rules: $G_\lambda G_\mu = \sum_\nu N_{\lambda,\mu}^\nu G_\nu$. By the Verlinde formula, Eq. (2), the representations of the commutative fusion rule algebra are given by the characters $\chi_\rho(\lambda) = S_{\rho,\lambda}/S_{\rho,0}$, and therefore the multiplicities of the Coxeter exponents just reflect the multiplicity of the character χ_ρ in the representation given by the matrices G_λ . Di Francesco, Petkova and Zuber similarly observed [7, 8, 33] that there are non-negative integer valued matrix representations (nimreps, for short) of the $SU(n)_k$ fusion rules which decompose into the characters matching the diagonal part of some non-trivial $SU(n)_k$ modular invariants (mainly $SU(3)$). Graphs are then obtained by reading the matrices G_λ as adjacency matrices, with λ now chosen among the fundamental weights of $SU(n)$ generalizing appropriately the spin 1 weight for $SU(2)$. The classification of $SU(3)$ modular invariants [14] shows a similar pattern as the $SU(2)$ case, called \mathcal{A} - \mathcal{D} - \mathcal{E} , \mathcal{A} referring to the diagonal invariants, \mathcal{D} to “simple current invariants” and \mathcal{E} to exceptionals. Again, it is the nimreps associated to the \mathcal{D} and \mathcal{E} invariants which call for an explanation whereas the \mathcal{A} invariants just correspond to the original fusion rules: $G_\lambda = N_\lambda$. Why are there graphs and, even more, nimreps of the Verlinde fusion rules associated to modular invariants? This question has not been answered for a long time. Nahm found a relation between the diagonal part of $SU(2)$ modular invariants and Lie group exponents using quaternionic coset spaces [28], however, his construction does not explain the appearance of nimreps of fusion rules and seems impossible to be extended to other Lie groups e.g. $SU(3)$.

A first step in associating systematically nimreps of the Verlinde fusion rules was done by F. Xu [41] using nets of subfactors [26] arising from conformal inclusions of $SU(n)$ theories. However, only a small number of modular invariants comes from conformal inclusions, e.g. the D_4 , E_6 and E_8 invariants for $SU(2)$. Developing systematically the α -induction machinery [1, 3] for nets of subfactors, a notion originally introduced by Longo and Rehren [26], such nimreps were shown in [2, 3] to arise similarly from all (local) simple current extensions [38] of $SU(n)$ theories, thus covering in particular the D_{even} series for $SU(2)$. Yet, type II invariants (cf. D_{odd} and E_7 for $SU(2)$) were not treated in [2, 3].

In [4] we have constructed modular invariants from braided subfactors in a very general approach which unifies and develops further the ideas of α -induction [26, 41, 1, 2, 3] and Ocneanu’s double triangle algebras [30]. We started with a von Neumann factor N endowed with a system ${}_N\mathcal{X}_N$ of braided endomorphisms (“ N - N morphisms”). Such a braiding defines “statistics” matrices S and T [35, 12] which, as shown by Rehren [35], provide a unitary representation of $SL(2; \mathbb{Z})$ if it is non-degenerate. The statistics matrices are analogous to the Kac-Peterson matrices: T is diagonal, S is symmetric and $S_{\lambda,0} \geq S_{0,0} > 0$. (The label “0” now refers to the identity morphism $\text{id} \in {}_N\mathcal{X}_N$ which corresponds to the vacuum in applications.) Moreover, the endomorphism fusion rules are diagonalized by the statistical S-matrix, i.e. obey

the Verlinde formula Eq. (2) in the non-degenerate case. We then studied embeddings $N \subset M$ in larger factors M which are in a certain sense compatible with the braided system of endomorphisms; namely, such a subfactor $N \subset M$ is essentially given by specifying a canonical endomorphism within the system ${}_N\mathcal{X}_N$. Then one can apply α -induction which associates to an N - N morphism λ two M - M morphisms, α_λ^+ and α_λ^- . Motivated by the analysis in [3], we *defined* a matrix Z with entries

$$Z_{\lambda,\mu} = \langle \alpha_\lambda^+, \alpha_\mu^- \rangle, \quad \lambda, \mu \in {}_N\mathcal{X}_N, \quad (3)$$

where the brackets denote the dimension of the intertwiner space $\text{Hom}(\alpha_\lambda^+, \alpha_\mu^-)$. Then Z automatically fulfills the conditions of Eq. (1) and we showed that it commutes with S and T [4, Thm. 5.7]. The inclusion $N \subset M$ associates to ${}_N\mathcal{X}_N$ a system ${}_M\mathcal{X}_M$ of M - M morphisms as well as “intermediate” systems ${}_N\mathcal{X}_M$ and ${}_M\mathcal{X}_N$ where the latter are related by conjugation. In turn, one obtains a (graded) fusion rule algebra from the sector products. Decomposing the induced morphisms α_λ^\pm into irreducibles yields “chiral” subsystems of M - M morphisms, and it was shown that the whole system ${}_M\mathcal{X}_M$ is generated by the chiral systems whenever the original braiding is non-degenerate [4, Thm. 5.10]. We showed that each non-zero entry $Z_{\lambda,\mu}$ labels one of the irreducible representations of the M - M fusion rules and its dimensions is exactly given by $Z_{\lambda,\mu}$ [4, Thm. 6.8]. Moreover, we showed that the irreducible decomposition of the representation obtained by multiplying M - M morphisms on M - N morphisms corresponds exactly to the diagonal part of the modular invariant [4, Thm. 6.12].

In this paper we take the analysis further and investigate the chiral induced systems. The matrix entry of Eq. (3) can be written as

$$Z_{\lambda,\mu} = \sum_\tau b_{\tau,\lambda}^+ b_{\tau,\mu}^-,$$

where the sum runs over morphisms τ in the “ambichiral” intersection of the chiral systems, and $b_{\tau,\lambda}^\pm = \langle \tau, \alpha_\lambda^\pm \rangle$ are the chiral branching coefficients. Analogous to the second interpretation of the entries of Z , we show that the chiral branching coefficients are at the same time the dimensions of the irreducible representations of the chiral fusion rules. We can evaluate the induced morphisms α_λ^\pm in all these representations of the chiral or full M - M fusion rule algebra. The representation which decomposes according to the diagonal part of the modular invariant is the one obtained by multiplying M - M morphisms on the M - N system. By evaluating α_λ^+ (here α_λ^- yields the same) we obtain a family of matrices G_λ . Since α -induction preserves the fusion rules, this provides a matrix representation of the original N - N (Verlinde) fusion rule algebra, $G_\lambda G_\mu = \sum_\nu N_{\lambda,\mu}^\nu G_\nu$, which therefore must decompose into the characters given in terms of the S-matrix. Moreover, as the G_λ ’s are just fusion matrices (i.e. each entry is the dimension of a finite-dimensional intertwiner space), we have in fact obtained nimreps here. We are able to compute the eigenvalues of the matrices and thus we determine the multiplicities of the characters, proving that χ_λ appears in it exactly with multiplicity $Z_{\lambda,\lambda}$.

The structure of the induced M - M system is quite different from the original braided N - N system. In general, neither the full system ${}_M\mathcal{X}_M$ nor the chiral induced

subsystems are braided, they can even have non-commutative fusion. In fact, our results show that the entire M - M fusion algebra (respectively a chiral fusion algebra) is non-commutative if and only if an entry of Z (respectively a chiral branching coefficient) is strictly larger than one. However, as constructed in [3], there is a relative braiding between the chiral induced systems which restricts to a proper braiding on the ambichiral system. We show that the ambichiral braiding is non-degenerate provided that the original braiding on ${}_N\mathcal{X}_N$ is.

Contact with conformal field theory, in particular with $SU(n)$ WZW models, is made through Wassermann’s loop group construction [39]. The factor N can be viewed as $\pi_0(L_I SU(n))''$, a local loop group in the level k vacuum representation. Wassermann’s bimodules corresponding to the positive energy representations yield the system of N - N morphisms, labelled by the the $SU(n)$ level k admissible weights and obeying the $SU(n)_k$ fusion rules by [39]. The statistics matrices S and T are then forced to coincide with the $SU(n)_k$ Kac-Peterson matrices, so that $Z_{\lambda,\mu} = \langle \alpha_\lambda^+, \alpha_\mu^- \rangle$ produced from subfactors $N \subset M$ will in fact give modular invariants of the $SU(n)_k$ WZW models.

Can any modular invariant of, say, $SU(n)$ models, be realized from some subfactor? We tend to believe that this is true. A systematic construction of canonical endomorphisms is available for all modular invariants arising from conformal inclusions [41, 2, 3] or by simple currents [2, 3]; the canonical endomorphism for modular invariants from non-local simple currents (with fractional conformal dimensions) can be obtained in the same way as in the local case [2, 3] since the “chiral locality condition” is no longer required to hold in our general framework. Maybe not too surprising for experts in modular invariants, it is the few — in Gannon’s language — \mathcal{E}_7 type invariants for which we do not (yet?) have a systematic construction. Nevertheless we can realize the complete list of $SU(2)$ modular invariants, including E_7 . We can determine the structure of the induced systems completely and we can draw the simultaneous fusion graphs of the left and right chiral generators. For D_{even} , E_6 and E_8 this was already presented in [3], and here we present the remaining cases D_{odd} and E_7 . As in [3] we obtain Ocneanu’s pictures for the “quantum symmetries of Coxeter graphs” [30], a coincidence which reflects the identification of α -induced sectors with chiral generators in the double triangle algebra [4, Thm. 5.3].

This paper is organized as follows. In Sect. 2 we recall some basic facts and notations from [4] and introduce more intertwining braiding fusion symmetry. In Sect. 3 we introduce basic notions and we start to analyze the structure of the chiral induced system. As a by-product, we show in our setting that $Z_{\lambda,0} = \delta_{\lambda,0}$ implies that Z is a permutation matrix corresponding to a fusion rule automorphism, even if the braiding is degenerate. Sect. 4 contains the main results. We assume non-degeneracy of the braiding on ${}_N\mathcal{X}_N$ and show that then the ambichiral braiding is non-degenerate. We decompose the chiral parts of the center of the double triangle algebra into simple matrix blocks, corresponding to a “diagonalization” of the chiral fusion rule algebras. We evaluate the chiral generators in the simple matrix blocks, corresponding to the evaluation of the induced morphisms in the irreducible representations of the chiral

fusion rule algebras. Sects. 5 and 6 are devoted to examples. In Sect. 5 we realize the remaining $SU(2)$ invariants D_{odd} and E_7 , and we give an overview over all A-D-E cases. We also discuss the nimreps of the Verlinde fusion rules and the problems in finding an underlying fusion rule structure for the type II invariants, a problem which was noticed by Di Francesco and Zuber [7, 8], based on an observation of Pasquier [32] who noticed that for Dynkin diagrams A, D_{even} , E_6 and E_8 there exist positive fusion rules, but not for D_{odd} and E_7 . In Sect. 6 we present more examples arising from conformal inclusions of $SU(3)$. Finally we discuss examples of non-trivial inclusions producing the trivial modular invariants as well as degenerate examples.

2 Preliminaries

Let A, B be infinite factors. We denote by $\text{Mor}(A, B)$ the set of unital $*$ -homomorphisms from A to B . The statistical dimension of $\rho \in \text{Mor}(A, B)$ is defined as $d_\rho = [B : \rho(A)]^{1/2}$ where $[B : \rho(A)]$ is the minimal index [20, 24]. A morphism $\rho \in \text{Mor}(A, B)$ is called irreducible if $\rho(A) \subset B$ is irreducible, i.e. $\rho(A)' \cap B = \mathbb{C}\mathbf{1}_B$. Two morphisms $\rho, \rho' \in \text{Mor}(A, B)$ are called equivalent if there is a unitary $u \in B$ such that $\rho' = \text{Ad}(u) \circ \rho$. The unitary equivalence class $[\rho]$ of a morphism $\rho \in \text{Mor}(A, B)$ is called a B - A sector. For sectors we have a notion of sums, products and conjugates (cf. [4, Sect. 2] and the references therein for more details). For $\rho, \tau \in \text{Mor}(A, B)$ we denote $\text{Hom}(\rho, \tau) = \{t \in B : t\rho(a) = \tau(a)t, a \in A\}$ and $\langle \rho, \tau \rangle = \dim \text{Hom}(\rho, \tau)$. Let N be a type III factor equipped with a system $\Delta \subset \text{Mor}(N, N)$ of endomorphisms in the sense of [4, Def. 2.1]. This means essentially that the morphisms in Δ are irreducible and have finite statistical dimension and, as sectors, they are different and form a closed fusion rule algebra. Then $\Sigma(\Delta) \subset \text{Mor}(N, N)$ denotes the set of morphisms which decompose as sectors into finite sums of elements in Δ . We assume the system Δ to be braided in the sense of [4, Def. 2.2] and we extend the braiding to $\Sigma(\Delta)$ (see [4, Subsect. 2.2]). We then consider a subfactor $N \subset M$, i.e. N embedded into another type III factor M , of that kind that the dual canonical endomorphism sector $[\theta]$ decomposes in a finite sum of sectors of morphisms in Δ , i.e. $\theta \in \Sigma(\Delta)$. Here $\theta = \bar{\iota} \iota$ with $\iota : N \hookrightarrow M$ being the injection map and $\bar{\iota} \in \text{Mor}(M, N)$ being a conjugate morphism. Note that this forces the statistical dimension of θ and thus the index of $N \subset M$ to be finite, $d_\theta = [M : N] < \infty$. Then we can define α -induction [1] along the lines of [4] just by using the extension formula of Longo and Rehren [26], i.e. by putting

$$\alpha_\lambda^\pm = \bar{\iota}^{-1} \circ \text{Ad}(\varepsilon^\pm(\lambda, \theta)) \circ \lambda \circ \bar{\iota}$$

for $\lambda \in \Sigma(\Delta)$, using braiding operators $\varepsilon^\pm(\lambda, \theta) \in \text{Hom}(\lambda\theta, \theta\lambda)$. Then α_λ^+ and α_λ^- are morphisms in $\text{Mor}(M, M)$ satisfying in particular $\alpha_\lambda^\pm \iota = \iota \lambda$.

In [3, Subsect. 3.3], a relative braiding between representative endomorphisms of subsectors of $[\alpha_\lambda^+]$ and $[\alpha_\mu^-]$ was introduced. Namely, if $\beta_+, \beta_- \in \text{Mor}(M, M)$ are such that $[\beta_+]$ and $[\beta_-]$ are subsectors of $[\alpha_\lambda^+]$ and $[\alpha_\mu^-]$ for some $\lambda, \mu \in \Sigma(\Delta)$, respectively, then

$$\mathcal{E}_r(\beta_+, \beta_-) = S^* \alpha_\mu^-(T^*) \varepsilon^+(\lambda, \mu) \alpha_\lambda^+(S) T \in \text{Hom}(\beta_+ \beta_-, \beta_- \beta_+)$$

is unitary where $T \in \text{Hom}(\beta_+, \alpha_\lambda^+)$ and $S \in \text{Hom}_M(\beta_-, \alpha_\mu^-)$ are isometries. It was shown that $\mathcal{E}_r(\beta_+, \beta_-)$ does not depend on $\lambda, \mu \in \Sigma(\Delta)$ and not on the isometries S, T , in the sense that, if there are isometries $X \in \text{Hom}(\beta_+, \alpha_\nu^+)$ and $Y \in \text{Hom}(\beta_-, \alpha_\rho^-)$ with some $\nu, \rho \in \Sigma(\Delta)$, then $\mathcal{E}_r(\beta_+, \beta_-) = Y^* \alpha_\rho^-(X^*) \varepsilon^+(\nu, \rho) \alpha_\nu^+(Y) X$. Moreover, it was shown¹ in [3, Prop. 3.12] that the system of unitaries $\mathcal{E}_r(\beta_+, \beta_-)$ provides a relative braiding between representative endomorphisms of subsectors of $[\alpha_\lambda^+]$ and $[\alpha_\mu^-]$ in the sense that, if $\beta_+, \beta_-, \beta'_+, \beta'_- \in \text{Mor}(M, M)$ are such that $[\beta_+], [\beta_-], [\beta'_+], [\beta'_-]$ are subsectors of $[\alpha_\lambda^+], [\alpha_\mu^-], [\alpha_\nu^+], [\alpha_\rho^-]$, respectively, $\lambda, \mu, \nu, \rho \in \Sigma(\Delta)$, then we have “initial conditions” $\mathcal{E}_r(\text{id}, \beta_-) = \mathcal{E}_r(\beta_+, \text{id}) = \mathbf{1}$, “composition rules”

$$\begin{aligned}\mathcal{E}_r(\beta_+ \beta'_+, \beta_-) &= \mathcal{E}_r(\beta_+, \beta_-) \beta_+ (\mathcal{E}_r(\beta'_+, \beta_-)), \\ \mathcal{E}_r(\beta_+, \beta_- \beta'_-) &= \beta_- (\mathcal{E}_r(\beta_+, \beta'_-)) \mathcal{E}_r(\beta_+, \beta_-),\end{aligned}\tag{4}$$

and whenever $Q_+ \in \text{Hom}(\beta_+, \beta'_+)$ and $Q_- \in \text{Hom}(\beta_-, \beta'_-)$ then we have “naturality”

$$\beta_- (Q_+) \mathcal{E}_r(\beta_+, \beta_-) = \mathcal{E}_r(\beta'_+, \beta_-) Q_+, \quad Q_- \mathcal{E}_r(\beta_+, \beta_-) = \mathcal{E}_r(\beta_+, \beta'_-) \beta_+ (Q_-).\tag{5}$$

Now let also $\beta''_\pm \in \text{Mor}(M, M)$ and $T_\pm \in \text{Hom}(\beta''_\pm, \beta_\pm \beta'_\pm)$ be an intertwiner. From Eqs. (4) and (5) we obtain the following braiding fusion relations:

$$\begin{aligned}\beta_- (T_+) \mathcal{E}_r(\beta''_+, \beta_-) &= \mathcal{E}_r(\beta_+, \beta_-) \beta_+ (\mathcal{E}_r(\beta'_+, \beta_-)) T_+ \\ T_- \mathcal{E}_r(\beta_+, \beta''_-) &= \beta_- (\mathcal{E}_r(\beta_+, \beta'_-)) \mathcal{E}_r(\beta_+, \beta_-) \beta_+ (T_-) \\ \beta_- (T_+)^* \mathcal{E}_r(\beta_+, \beta_-) \beta_+ (\mathcal{E}_r(\beta'_+, \beta_-)) &= \mathcal{E}_r(\beta''_+, \beta_-) T_+^* \\ T_-^* \beta_- (\mathcal{E}_r(\beta_+, \beta'_-)) \mathcal{E}_r(\beta_+, \beta_-) &= \mathcal{E}_r(\beta_+, \beta''_-) \beta_+ (T_-)^*.\end{aligned}\tag{6}$$

We can include the relative braiding operators in the “graphical intertwiner calculus” along the lines of [4] where isometric intertwiners (with certain prefactors) realizing “fusion channels” and unitary braiding operators are diagrammatically represented by trivalent vertices and crossings, respectively. Again, the symmetry relations fulfilled by the relative braiding operators determine topological moves of the corresponding wire diagrams, similar to Figs. 13,14,15 in [4].

If $a \in \text{Mor}(M, N)$ is such that $[a]$ is a subsector of $\mu \bar{\nu}$ for some μ in $\Sigma(\Delta)$ then $a \nu \in \Sigma(\Delta)$. Hence the braiding operators $\varepsilon^\pm(\lambda, a \nu)$ are well defined for $\lambda \in \Sigma(\Delta)$. We showed in [4, Prop. 3.1] that $\varepsilon^\pm(\lambda, a \nu) \in \text{Hom}(\lambda a, a \alpha_\lambda^\pm)$. If $\bar{b} \in \text{Mor}(N, M)$ is such that $[\bar{b}]$ is a subsector of $[\nu \bar{\nu}]$ for some $\bar{\nu} \in \Sigma(\Delta)$ and $T \in \text{Hom}(\bar{b}, \nu \bar{\nu})$ is an isometry, then we showed that $\mathcal{E}^\pm(\lambda, \bar{b}) = T^* \varepsilon^\pm(\lambda, \bar{\nu}) \alpha_\lambda^\pm(T)$ (and $\mathcal{E}^\pm(\bar{b}, \lambda) = \mathcal{E}^\mp(\lambda, \bar{b})^*$) are independent of the particular choice of $\bar{\nu}$ and T and are unitaries in $\text{Hom}(\alpha_\lambda^\pm \bar{b}, \bar{b} \lambda)$ (respectively $\text{Hom}(\bar{b} \lambda, \alpha_\lambda^\mp \bar{b})$). These operators obey certain symmetry relations [4, Prop. 3.3] which we called “intertwining braiding fusion relations” (IBFE’s), and they can nicely be represented graphically by “mixed crossings” which involve “thick wires” representing N - M morphisms (see [4, Fig. 30]). We will now complete the picture by relating their braiding symmetry to the relative braiding by means of additional IBFE’s.

¹The proof of [3, Prop. 3.12] is actually formulated in the context of nets of subfactors. However, the proof is exactly the same in the setting of braided subfactors and it does not depend on the chiral locality condition.

Lemma 2.1 *Let $\lambda, \mu, \nu \in \Sigma(\Delta)$, $\beta_{\pm} \in \text{Mor}(M, M)$ $a, b \in \text{Mor}(M, N)$ such that $[\beta_{\pm}]$, $[a]$, $[b]$ are subsectors of $[\alpha_{\lambda}^{\pm}]$, $[\mu^{\pm}]$ and $[\nu^{\pm}]$ respectively. Let also $\bar{a}, \bar{b} \in \text{Mor}(N, M)$ be conjugates of a, b , respectively. Then we have*

$$\mathcal{E}^+(\beta_+ \bar{b}, \rho) = \mathcal{E}_r(\beta_+, \alpha_{\rho}^-) \beta_+ (\mathcal{E}^+(\bar{b}, \rho)), \quad \mathcal{E}^-(\beta_- \bar{b}, \rho) = \mathcal{E}_r(\alpha_{\rho}^+, \beta_-)^* \beta_- (\mathcal{E}^-(\bar{b}, \rho)), \quad (7)$$

and

$$\varepsilon^+(\rho, b \beta_- \iota) = b (\mathcal{E}_r(\alpha_{\rho}^+, \beta_-)) \varepsilon^+(\rho, b \iota), \quad \varepsilon^-(\rho, b \beta_+ \iota) = b (\mathcal{E}_r(\beta_+, \alpha_{\rho}^-))^* \varepsilon^-(\rho, b \iota), \quad (8)$$

for all $\rho \in \Sigma(\Delta)$.

Proof. Let $S_{\pm} \in \text{Hom}(\beta_{\pm}, \alpha_{\lambda}^{\pm})$ and $T \in \text{Hom}(\bar{b}, \iota \bar{\nu})$ be isometries. Then we have

$$\mathcal{E}_r(\beta_+, \alpha_{\rho}^-) = \alpha_{\rho}^- (S_+)^* \varepsilon^+(\lambda, \rho) S_+, \quad \mathcal{E}_r(\alpha_{\rho}^+, \beta_-)^* = \alpha_{\rho}^+ (S_-)^* \varepsilon^-(\lambda, \rho) S_-,$$

and

$$\mathcal{E}^{\pm}(\bar{b}, \rho) = \alpha_{\rho}^{\mp} (T)^* \varepsilon^{\pm}(\bar{\nu}, \rho) T.$$

Since $\alpha_{\lambda}^{\pm} (T) S_{\pm} \in \text{Hom}(\beta_{\pm} \bar{b}, \alpha_{\lambda}^{\pm} \iota \bar{\nu}) \equiv \text{Hom}(\beta_{\pm} \bar{b}, \iota \lambda \bar{\nu})$ is an isometry we can compute

$$\begin{aligned} \mathcal{E}^{\pm}(\beta_{\pm} \bar{b}, \rho) &= \alpha_{\rho}^{\mp} (S_{\pm}^* \alpha_{\lambda}^{\pm} (T)^*) \varepsilon^{\pm}(\lambda \bar{\nu}, \rho) \alpha_{\lambda}^{\pm} (T) S_{\pm} \\ &= \alpha_{\rho}^{\mp} (S_{\pm})^* \alpha_{\rho}^{\mp} \alpha_{\lambda}^{\pm} (T)^* \varepsilon^{\pm}(\lambda, \rho) \lambda (\varepsilon^{\pm}(\bar{\nu}, \rho)) \alpha_{\lambda}^{\pm} (T) S_{\pm} \\ &= \alpha_{\rho}^{\mp} (S_{\pm})^* \varepsilon^{\pm}(\lambda, \rho) \alpha_{\lambda}^{\pm} \alpha_{\rho}^{\mp} (T)^* \lambda (\varepsilon^{\pm}(\bar{\nu}, \rho)) \alpha_{\lambda}^{\pm} (T) S_{\pm} \\ &= \alpha_{\rho}^{\mp} (S_{\pm})^* \varepsilon^{\pm}(\lambda, \rho) S_{\pm} \beta_{\pm} (\alpha_{\rho}^{\mp} (T)^* \varepsilon^{\pm}(\bar{\nu}, \rho) T), \end{aligned}$$

which gives the desired Eq. (7). Here we have used that $\varepsilon^{\pm}(\lambda, \rho) \in \text{Hom}(\alpha_{\lambda}^{\pm} \alpha_{\rho}^{\mp}, \alpha_{\rho}^{\mp} \alpha_{\lambda}^{\pm})$ by [1, Lemma 3.24]. Since $b (S_{\pm})^* \in \text{Hom}(b \alpha_{\lambda}^{\pm} \iota, b \beta_{\pm} \iota) \equiv \text{Hom}(b \iota \lambda, b \beta_{\pm} \iota)$ we can compute by virtue of naturality (cf. [4, Eq. (8)])

$$\begin{aligned} \varepsilon^{\pm}(\rho, b \beta_{\pm} \iota) &= \varepsilon^{\pm}(\rho, b \beta_{\pm} \iota) \rho b (S_{\pm}^* S_{\pm}) = b (S_{\pm})^* \varepsilon^{\pm}(\rho, b \iota \lambda) \rho b (S_{\pm}) \\ &= b (S_{\pm})^* b (\varepsilon^{\pm}(\rho, \lambda)) \varepsilon^{\pm}(\rho, b \iota) \rho b (S_{\pm}) \\ &= b (S_{\pm})^* b (\varepsilon^{\pm}(\rho, \lambda)) b \alpha_{\rho}^{\pm} (S_{\pm}) \varepsilon^{\pm}(\rho, b \iota), \end{aligned}$$

which gives the desired Eq. (8). □

From the naturality equations for the braiding operators [4, Lemma 3.2] and [1, Lemma 3.25] we then obtain the following

Corollary 2.2 *For $X_{\pm} \in \text{Hom}(\bar{a}, \beta_{\pm} \bar{b})$ and $x_{\pm} \in \text{Hom}(a, \beta_{\pm} b)$ we have IBFE's*

$$\begin{aligned} \alpha_{\rho}^- (X_+) \mathcal{E}^+(\bar{a}, \rho) &= \mathcal{E}_r(\beta_+, \alpha_{\rho}^-) \beta_+ (\mathcal{E}^+(\bar{b}, \rho)) X_+, \\ \alpha_{\rho}^+ (X_-) \mathcal{E}^-(\bar{a}, \rho) &= \mathcal{E}_r(\alpha_{\rho}^+, \beta_-)^* \beta_- (\mathcal{E}^-(\bar{b}, \rho)) X_-, \end{aligned} \quad (9)$$

and

$$\begin{aligned} x_+ \varepsilon^-(\rho, a \iota) &= b (\mathcal{E}_r(\beta_+, \alpha_{\rho}^-))^* \varepsilon^-(\rho, b \iota) \rho (x_+), \\ x_- \varepsilon^+(\rho, a \iota) &= b (\mathcal{E}_r(\alpha_{\rho}^+, \beta_-)) \varepsilon^+(\rho, b \iota) \rho (x_-). \end{aligned} \quad (10)$$

These IBFE's can again be visualized in diagrams. We leave this as an exercise to the reader.

Next we recall our definition of Ocneanu's double triangle algebra. For the above considerations we did not need finiteness of the system Δ . For the definition of the double triangle algebra we do need such a finiteness assumption but it does not rely on the braiding. Therefore we start again and work for the rest of this paper with the following

Assumption 2.3 Let $N \subset M$ be a type III subfactor of finite index. We assume that we have a finite system of endomorphisms ${}_N\mathcal{X}_N \subset \text{Mor}(N, N)$ in the sense of [4, Def. 2.1] such that $\theta = \bar{\iota} \iota \in \Sigma({}_N\mathcal{X}_N)$ for the injection map $\iota : N \hookrightarrow M$ and a conjugate $\bar{\iota} \in \text{Mor}(M, N)$. We choose sets of morphisms ${}_N\mathcal{X}_M \subset \text{Mor}(M, N)$, ${}_M\mathcal{X}_N \subset \text{Mor}(N, M)$ and ${}_M\mathcal{X}_M \subset \text{Mor}(M, M)$ consisting of representative endomorphisms of irreducible subsectors of sectors of the form $[\lambda\bar{\iota}]$, $[\iota\lambda]$ and $[\iota\lambda\bar{\iota}]$, $\lambda \in {}_N\mathcal{X}_N$, respectively. We choose $\text{id} \in \text{Mor}(M, M)$ representing the trivial sector in ${}_M\mathcal{X}_M$.

Then the the double triangle algebra \diamond is given as a linear space by

$$\diamond = \bigoplus_{a,b,c,d \in {}_N\mathcal{X}_M} \text{Hom}(a\bar{b}, c\bar{d})$$

and is equipped with two different multiplications; the horizontal product $*_h$ and the vertical product $*_v$ (cf. [4, Sect. 4]). The center \mathcal{Z}_h of $(\diamond, *_h)$ is closed under the vertical product. In fact, the algebra $(\mathcal{Z}_h, *_v)$ is isomorphic to the fusion rule algebra associated to the system ${}_M\mathcal{X}_M$ (cf. [4, Thm. 4.4]). This fact provides a useful tool since in examples the system ${}_N\mathcal{X}_N$ is typically the known part of the theory whereas the dual system ${}_M\mathcal{X}_M$ is the unknown part. To determine the structure of the fusion rule algebra of ${}_M\mathcal{X}_M$, i.e. of $(\mathcal{Z}_h, *_v)$, completely is often a rather difficult problem. However, a braiding on ${}_N\mathcal{X}_N$ forces a lot of symmetry structure within the entire set \mathcal{X} which can in turn be enough to determine the whole M - M fusion table completely. For the rest of this paper we therefore now impose the following

Assumption 2.4 In addition to Assumption 2.3 we now assume that the system ${}_N\mathcal{X}_N$ is braided in the sense of [4, Def. 2.2].

In particular we then have the notion of α -induction. The relation $\alpha_\lambda^\pm \iota = \iota \lambda$ implies that for any $\lambda \in {}_N\mathcal{X}_N$ each irreducible subsector of $[\alpha_\lambda^\pm]$ is of the form $[\beta]$ for some $\beta \in {}_M\mathcal{X}_M$. By ${}_M\mathcal{X}_M^\pm \subset {}_M\mathcal{X}_M$ we denote the subsets corresponding to subsectors of $[\alpha_\lambda^\pm]$ when λ varies in ${}_N\mathcal{X}_N$. By virtue of the homomorphism property of α -induction, the sets ${}_M\mathcal{X}_M^\pm$ must in fact be systems of endomorphism themselves. We call ${}_M\mathcal{X}_M^+$ and ${}_M\mathcal{X}_M^-$ the *chiral systems*. Clearly, another system is obtained by taking the intersection ${}_M\mathcal{X}_M^0 = {}_M\mathcal{X}_M^+ \cap {}_M\mathcal{X}_M^-$ which we call the *ambichiral system*. In this paper, we will make special use of the relative braiding between ${}_M\mathcal{X}_M^+$ and ${}_M\mathcal{X}_M^-$. Note that the relative braiding restricts to a proper braiding on ${}_M\mathcal{X}_M^0$. The relative braiding

symmetry also gives rise to new useful graphical identities. Let $\beta_{\pm}, \beta'_{\pm} \in {}_M\mathcal{X}_M^{\pm}$ and $V_{\pm} \in \text{Hom}(\beta_{\pm}, \alpha_{\lambda}^{\pm})$. From naturality Eq. (5) we obtain

$$\begin{aligned} \beta'_-(V_+) \mathcal{E}_r(\beta_+, \beta'_-) &= \mathcal{E}_r(\alpha_{\lambda}^+, \beta'_-) V_+, \\ V_- \mathcal{E}_r(\beta'_+, \beta_-) &= \mathcal{E}_r(\beta'_+, \alpha_{\lambda}^-) \beta'_+(V_-). \end{aligned} \quad (11)$$

We only display the first relation in Fig. 1.

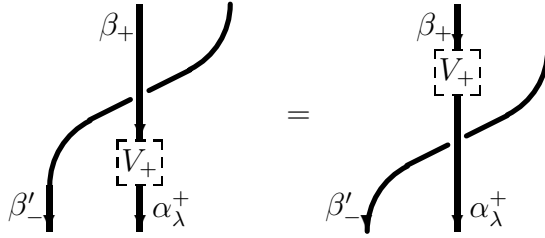

Figure 1: Naturality move for relative braiding

Recall that we defined [4, Def. 5.5] a matrix Z by setting

$$Z_{\lambda, \mu} = \langle \alpha_{\lambda}^+, \alpha_{\mu}^- \rangle, \quad \lambda, \mu \in {}_N\mathcal{X}_N,$$

and we showed in [4, Thm. 5.7] that it commutes with Rehren's monodromy matrix Y and statistics T-matrix which have matrix elements

$$Y_{\lambda, \mu} = \sum_{\nu} \frac{\omega_{\lambda} \omega_{\mu}}{\omega_{\nu}} N_{\lambda, \mu}^{\nu} d_{\nu}, \quad T_{\lambda, \mu} = \delta_{\lambda, \mu} e^{-i\pi c/12} \omega_{\lambda}, \quad \lambda, \mu \in {}_N\mathcal{X}_N, \quad (12)$$

where $c = 4 \arg(\sum_{\nu} \omega_{\nu} d_{\nu}^2) / \pi$. As Z has by definition non-negative integer entries and satisfies $Z_{0,0} = 1$ (the label “0” stands as usual for the identity morphism $\text{id} \in {}_N\mathcal{X}_N$), it therefore constitutes a modular invariant in the sense of conformal field theory whenever the braiding is non-degenerate because matrices $S = w^{-1/2} Y$ and T obey the modular Verlinde algebra in that case [35] (see also [12, 11] or our review in [4, Subsect. 2.2]).

3 Chiral analysis

In this section we begin to analyze the structure of the chiral systems ${}_M\mathcal{X}_M^{\pm}$. So far the analysis will be carried out without an assumption of non-degeneracy of the braiding, and in fact several structures appear independently of it.

3.1 Chiral horizontal projectors and chiral global indices

Let $w_{\pm} = \sum_{\beta \in {}_M\mathcal{X}_M^{\pm}} d_{\beta}^2$. We call w_+ and w_- the *chiral global indices*. In the double triangle algebra, we define $P^{\pm} = \sum_{\beta \in {}_M\mathcal{X}_M^{\pm}} e_{\beta}$. We call (slightly different from Ocneanu's definition) P^+ and P^- chiral horizontal projectors.

Proposition 3.1 *In the M - M fusion rule algebra we have*

$$\sum_{\lambda \in_N \mathcal{X}_N} d_\lambda [\alpha_\lambda^\pm] = \frac{w}{w_\pm} \sum_{\beta \in_M \mathcal{X}_M^\pm} d_\beta [\beta] \quad (13)$$

and consequently $\sum_{\lambda \in_N \mathcal{X}_N} p_\lambda^\pm = ww_\pm^{-1} P^\pm$ in the double triangle algebra. Moreover, the chiral global indices coincide and are given by

$$w_+ = w_- = \frac{w}{\sum_{\lambda \in_N \mathcal{X}_N} d_\lambda Z_{\lambda,0}}. \quad (14)$$

Proof. Put $\Gamma_{\lambda;\beta}^{\beta',\pm} = \langle \beta \alpha_\lambda^\pm, \beta' \rangle$ for $\lambda \in_N \mathcal{X}_N$ and $\beta, \beta' \in_M \mathcal{X}_M^\pm$. This defines square matrices Γ_λ^\pm and we have $\Gamma_\lambda^\pm = \sum_{\beta \in_M \mathcal{X}_M^\pm} \langle \beta, \alpha_\lambda^\pm \rangle N_\beta$ where the N_β 's are the fusion matrices of β within $_M \mathcal{X}_M^\pm$. With these, the matrices Γ_λ^\pm therefore share the simultaneous eigenvector \vec{d}^\pm , defined by entries d_β , $\beta \in_M \mathcal{X}_M^\pm$, with respective eigenvalues d_λ . Note that the sum matrix $Q^\pm = \sum_\lambda \Gamma_\lambda^\pm$ is irreducible since each $[\beta]$ with $\beta \in_M \mathcal{X}_M^\pm$ is a subsector of some $[\alpha_\lambda^\pm]$ by definition. Now define another vector \vec{v}^\pm with entries $v_\beta^\pm = \sum_\lambda d_\lambda \langle \beta, \alpha_\lambda^\pm \rangle$, $\beta \in_M \mathcal{X}_M^\pm$. Note that all entries are positive. We now compute

$$\begin{aligned} (\Gamma_\lambda^\pm \vec{v}^\pm)_\beta &= \sum_{\beta' \in_M \mathcal{X}_M^\pm} \sum_{\nu \in_N \mathcal{X}_N} \langle \beta \alpha_\lambda^\pm, \beta' \rangle d_\nu \langle \beta', \alpha_\nu^\pm \rangle = \sum_{\nu \in_N \mathcal{X}_N} d_\nu \langle \beta \alpha_\lambda^\pm, \alpha_\nu^\pm \rangle \\ &= \sum_{\mu, \nu \in_N \mathcal{X}_N} N_{\nu, \lambda}^\mu d_\nu \langle \beta, \alpha_\mu^\pm \rangle = \sum_{\mu \in_N \mathcal{X}_N} d_\lambda d_\mu \langle \beta, \alpha_\mu^\pm \rangle = d_\lambda v_\beta^\pm, \end{aligned}$$

i.e. $\Gamma_\lambda^\pm \vec{v}^\pm = d_\lambda \vec{v}^\pm$. Hence \vec{v}^\pm is another eigenvector of Q with the same eigenvalue $\sum_\lambda d_\lambda$. By uniqueness of the Perron-Frobenius eigenvector it follows $v_\beta^\pm = \zeta_\pm d_\beta$ for all $\beta \in_M \mathcal{X}_M^\pm$ with some number $\zeta_\pm \in \mathbb{C}$. We can determine this number in two different ways. We first find that now $\sum_\lambda d_\lambda [\alpha_\lambda^\pm] = \sum_{\beta \in_M \mathcal{X}_M^\pm} v_\beta^\pm [\beta] = \sum_{\beta \in_M \mathcal{X}_M^\pm} \zeta_\pm d_\beta [\beta]$. By computing the dimension we obtain $w = \zeta_\pm w_\pm$, establishing Eq. (13). On the other hand we can compare the zero-components: We clearly have $d_0 = 1$ whereas $v_0^\pm = \sum_\lambda d_\lambda \langle \text{id}, \alpha_\lambda^\pm \rangle$, i.e. $v_0^+ = \sum_\lambda d_\lambda Z_{\lambda,0}$ and $v_0^- = \sum_\lambda d_\lambda Z_{0,\lambda}$. But note that

$$\sum_{\lambda \in_N \mathcal{X}_N} d_\lambda Z_{\lambda,0} = (YZ)_{0,0} = (ZY)_{0,0} = \sum_{\lambda \in_N \mathcal{X}_N} Z_{0,\lambda} d_\lambda.$$

We have found

$$\frac{w}{w_\pm} = \zeta_\pm = \sum_{\lambda \in_N \mathcal{X}_N} d_\lambda Z_{\lambda,0},$$

and this proves the proposition. \square

Note that the $\text{Hom}(a\bar{a}, b\bar{b})$ part of the equality $\sum_\lambda p_\lambda^+ = ww_+^{-1} P^+$ gives us the graphical identity of Fig. 2. (And we obtain a similar identity for “−”.)

We next claim the following

Proposition 3.2 *The following conditions are equivalent:*

1. We have $Z_{0,\lambda} = \delta_{\lambda,0}$.

$$\sum_{\lambda} \begin{array}{c} a \\ | \\ \text{loop } \alpha_{\lambda}^+ \\ | \\ b \end{array} = \frac{w}{w_+} \sum_{\beta \in {}_M\mathcal{X}_M^+} \begin{array}{c} a \\ | \\ \text{loop } \beta \\ | \\ b \end{array}$$

Figure 2: Chiral generators sum up to chiral horizontal projectors

2. We have $Z_{\lambda,0} = \delta_{\lambda,0}$.
3. We have $w_+ = w$.
4. Z is a permutation matrix, $Z_{\lambda,\mu} = \delta_{\lambda,\pi(\mu)}$ where π is a permutation of ${}_N\mathcal{X}_N$ satisfying $\pi(0) = 0$ and defining a fusion rule automorphism of the N - N fusion rule algebra.

Proof. The implication 1. \Rightarrow 2. follows again from $\sum_{\lambda} d_{\lambda} Z_{\lambda,0} = \sum_{\lambda} Z_{0,\lambda} d_{\lambda}$ arising from $[Y, Z] = 0$. The implication 2. \Rightarrow 3. follows from Proposition 3.1. We next show the implication 3. \Rightarrow 4.: Because we have in general ${}_M\mathcal{X}_M^{\pm} \subset {}_M\mathcal{X}_M$, $w_+ = w_- = w$ means ${}_M\mathcal{X}_M^{\pm} = {}_M\mathcal{X}_M$. Consequently, $\sum_{\lambda \in {}_N\mathcal{X}_N} d_{\lambda} [\alpha_{\lambda}^{\pm}] = \sum_{\beta \in {}_M\mathcal{X}_M} d_{\beta} [\beta]$ in the M - M fusion rule algebra. Assume for contradiction that some $[\alpha_{\lambda}^{\pm}]$ is reducible. Then $d_{\beta} < d_{\lambda}$ if $[\beta]$ is a subsector. But $[\beta]$ appears on the left hand side with a coefficient larger or equal d_{λ} whereas with coefficient d_{β} on the right hand side which cannot be true. Hence all $[\alpha_{\lambda}^{\pm}]$'s are irreducible and as $w = w_+$, they must also be distinct. Therefore $\#_M\mathcal{X}_M^{\pm} = \#_N\mathcal{X}_N$, and consequently Z must be a permutation matrix: $Z_{\lambda,\mu} = \delta_{\lambda,\pi(\mu)}$ with $\pi(0) = 0$ as $Z_{0,0} = 0$. Moreover, by virtue of the homomorphism property of α -induction we have two isomorphisms $\vartheta_{\pm} : [\lambda] \mapsto [\alpha_{\lambda}^{\pm}]$ from the N - N into the M - M fusion rule algebra and consequently $\vartheta_+^{-1} \circ \vartheta_-([\mu]) = [\pi(\mu)]$ defines an automorphism of the N - N fusion rules. Finally, the implication 4. \Rightarrow 1. is trivial. \square

Note that the statement of Proposition 3.2 (except 3.) is well known for modular invariants in conformal field theory [15, 13] (see also [27]). However, it is remarkable that our statement does not rely on the non-degeneracy of the braiding, i.e. it holds even if there is no representation of the modular group around. An analogous statement has also been derived recently for the coupling matrix arising from the embedding of left and right chiral observables into a “canonical tensor product subfactor”, not relying on modularity either [37]. Yet our result turns up by considering chiral observables only.

3.2 Chiral branching coefficients

We will now introduce the chiral branching coefficients which play an important (twofold) role for the chiral systems, analogous to the role of the entries of the matrix

Z for the entire system.

Lemma 3.3 *We have*

$$\langle \beta, \alpha_\lambda^\pm \rangle = \frac{w}{d_\lambda d_\beta} \varphi_h(p_\lambda^\pm *_h e_\beta) \quad (15)$$

for any $\lambda \in {}_N\mathcal{X}_N$ and any $\beta \in {}_M\mathcal{X}_M$.

Proof. By [4, Thm. 5.3] we have

$$\frac{1}{d_\lambda} p_\lambda^\pm = \sum_{\beta \in {}_M\mathcal{X}_M} \frac{1}{d_\beta} \langle \beta, \alpha_\lambda^\pm \rangle e_\beta,$$

hence

$$\frac{1}{d_\lambda d_\beta} p_\lambda^\pm *_h e_\beta = \frac{1}{d_\beta^2} \langle \beta, \alpha_\lambda^\pm \rangle e_\beta.$$

Application of φ_h now yields the claim since $\varphi_h(e_\beta) = d_\beta^2/w$ by [4, Lemma 4.7] \square

Hence the number $\langle \beta, \alpha_\lambda^+ \rangle$ (and similarly $\langle \beta, \alpha_\lambda^- \rangle$) can be displayed graphically as in Fig. 3 (cf. the argument to get the picture for $Z_{\lambda,\mu}$ in [4, Thm. 5.6]). For

$$\langle \beta, \alpha_\lambda^+ \rangle = \sum_{b,c} \frac{d_b d_c}{w d_\lambda d_\beta} \alpha_\lambda^+ \beta$$

Figure 3: Graphical representation of $\langle \beta, \alpha_\lambda^+ \rangle$

$\tau \in {}_M\mathcal{X}_M^0$ we call the numbers $b_{\tau,\lambda}^\pm = \langle \tau, \alpha_\lambda^\pm \rangle$ *chiral branching coefficients*. Note that from $Z_{\lambda,\mu} = \langle \alpha_\lambda^+, \alpha_\mu^- \rangle$ we obtain the formula

$$Z_{\lambda,\mu} = \sum_{\tau \in {}_M\mathcal{X}_M^0} b_{\tau,\lambda}^+ b_{\tau,\mu}^- \quad (16)$$

Introducing rectangular matrices b^\pm with entries $(b^\pm)_{\tau,\lambda} = b_{\tau,\lambda}^\pm$ we can thus write $Z = \mathfrak{b}^+ b^-$. The name “chiral branching coefficients” is motivated from the case where chiral locality condition holds. The canonical sector restriction [26] of some morphism $\beta \in \text{Mor}(M, M)$ is given by $\sigma_\beta = \bar{\iota}\beta\iota \in \text{Mor}(N, N)$ and was named “ σ -restriction” in [1]. Now suppose $\beta \in {}_M\mathcal{X}_M$. Then $\sigma_\beta \in \Sigma({}_N\mathcal{X}_N)$. We put $b_{\tau,\lambda} = \langle \lambda, \sigma_\beta \rangle$ for $\lambda \in {}_N\mathcal{X}_N$. The following proposition is just the version of $\alpha\sigma$ -reciprocity [1, Thm. 3.21] in our setting of braided subfactors.

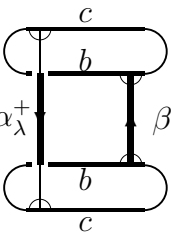
Proposition 3.4 *Whenever the chiral locality condition $\varepsilon^+(\theta, \theta)\gamma(v) = \gamma(v)$ holds then we have $b_{\tau, \lambda}^+ = b_{\tau, \lambda}^- = b_{\tau, \lambda}$ for all $\tau \in {}_M\mathcal{X}_M^0$, $\lambda \in {}_N\mathcal{X}_N$.*

Proof. Using chiral locality, it was proven in [3, Prop. 3.3] that $\langle \alpha_\lambda^\pm, \beta \rangle = \langle \lambda, \sigma_\beta \rangle$ whenever $[\beta]$ is a subsector of some $[\alpha_\mu^\pm]$. Hence

$$\langle \alpha_\lambda^+, \tau \rangle = \langle \lambda, \sigma_\tau \rangle = \langle \alpha_\lambda^-, \tau \rangle$$

for $\tau \in {}_M\mathcal{X}_M^0$. □

Note that, with chiral locality, the modular invariant matrix is written as $Z_{\lambda, \mu} = \sum_{\tau \in {}_M\mathcal{X}_M^0} b_{\tau, \lambda} b_{\tau, \mu}$, and this is exactly the expression which characterizes “block-diagonal” or “type I” invariants. In fact, in the net of subfactor setting, the numbers $\langle \lambda, \sigma_\beta \rangle$ describe the decomposition of restricted representations $\pi_0 \circ \beta$ as established in [26]. For conformal inclusions or simple current extensions treated in [2], the $b_{\tau, \lambda}$ ’s are exactly the branching coefficients because the ambichiral system corresponds to the DHR morphisms of the extended theory by the results of [3, 4]. Without chiral locality we only have $b_{\tau, \lambda}^\pm \leq b_{\tau, \lambda}$ similar to the inequality $\langle \alpha_\lambda^\pm, \alpha_\mu^\pm \rangle \leq \langle \theta \lambda, \mu \rangle$ which replaces the “main formula” of [1, Thm. 3.9].

3.3 Chiral vertical algebras

We define for each $\tau \in {}_M\mathcal{X}_M^0$ a vector space

$$\mathcal{A}_\tau = \bigoplus_{a, b \in {}_N\mathcal{X}_N} \text{Hom}(a\tau\bar{a}, b\tau\bar{b}),$$

and we endow it, similar to the double triangle algebra, with a vertical product \star_v defined graphically in Fig. 4. Then it is not hard to see that a complete set of matrix

Figure 4: Vertical product for \mathcal{A}_τ

units is given by elements $f_{\lambda; b, d, i, k}^{a, c, j, l}$ as defined in Fig. 5. They obey

$$f_{\lambda; b, d, i, k}^{a, c, j, l} \star_v f_{\lambda'; b', d', i', k'}^{a', c', j', l'} = \delta_{\lambda, \lambda'} \delta_{a, b'} \delta_{c, d'} \delta_{j, i'} \delta_{l, k'} f_{\lambda; b, d, i, k}^{a', c', j', l'}.$$

We define a functional ψ_v^τ as in Fig. 6. It fulfills $\psi_v^\tau(f_{\lambda; b, d, i, k}^{a, c, j, l}) = \delta_{a, b} \delta_{c, d} \delta_{i, j} \delta_{k, l} d_\lambda$, and

$$f_{\lambda;b,d,i,k}^{a,c,j,l} = \frac{1}{d_a d_b} \sqrt{\frac{d_\lambda}{d_\tau}}$$

Figure 5: Matrix units for \mathcal{A}_τ

$$\psi_v^\tau : \begin{array}{c} a \\ \downarrow \tau \\ \text{---} X \text{---} \\ \downarrow \tau \\ b \end{array} \mapsto \delta_{a,b} d_a \begin{array}{c} \text{---} X \text{---} \\ \uparrow \tau \\ a \\ \downarrow \tau \\ \text{---} X \text{---} \\ \downarrow \tau \\ b \end{array}$$

Figure 6: Trace for \mathcal{A}_τ

therefore it is a faithful (un-normalized) trace on \mathcal{A}_τ . We next define vector spaces $\mathcal{H}_{\tau,\lambda}$ by

$$\mathcal{H}_{\tau,\lambda} = \bigoplus_{a \in {}_N\mathcal{X}_M} \text{Hom}(\lambda, a\tau\bar{a}),$$

and special vectors $\omega_{b,c,t,X}^{\tau,\lambda,+} \in \mathcal{H}_{\tau,\lambda}$ and $\omega_{b,c,t,X}^{\tau,\lambda,-} \in \mathcal{H}_{\bar{\tau},\bar{\lambda}}$ as given in Fig. 7. Note that

$$\omega_{b,c,t,X}^{\tau,\lambda,+} = \sum_a \begin{array}{c} \lambda \\ \downarrow \\ \text{---} X^* \text{---} \\ \downarrow \tau \\ a \end{array} \quad \omega_{b,c,t,X}^{\tau,\lambda,-} = \sum_a \begin{array}{c} \lambda \\ \downarrow \\ \text{---} X \text{---} \\ \downarrow \tau \\ a \end{array}$$

Figure 7: The vectors $\omega_{b,c,t,X}^{\tau,\lambda,+} \in \mathcal{H}_{\tau,\lambda}$ and $\omega_{b,c,t,X}^{\tau,\lambda,-} \in \mathcal{H}_{\bar{\tau},\bar{\lambda}}$

such vectors may be linearly dependent. Let $H_{\tau,\lambda}^+ \subset \mathcal{H}_{\tau,\lambda}$ respectively $H_{\bar{\tau},\bar{\lambda}}^- \subset \mathcal{H}_{\bar{\tau},\bar{\lambda}}$ be the subspaces spanned by vectors $\omega_{b,c,t,X}^{\tau,\lambda,+}$ respectively $\omega_{b,c,t,X}^{\tau,\lambda,-}$ where $b, c \in {}_N\mathcal{X}_M$ and $t \in \text{Hom}(\lambda, b\bar{c})$ and $X \in \text{Hom}(\tau, \bar{c}b)$ are isometries. Now take such vectors $\omega_{b,c,t,X}^{\tau,\lambda,\pm}$ and $\omega_{b',c',t',X'}^{\tau,\lambda,\pm}$. We define an element $|\omega_{b',c',t',X'}^{\tau,\lambda,+}\rangle\langle\omega_{b,c,t,X}^{\tau,\lambda,+}| \in \mathcal{A}_\tau$ by the diagram

in Fig. 8. Analogously we define $|\omega_{b',c',t',X'}^{\tau,\lambda,-}\rangle\langle\omega_{b,c,t,X}^{\tau,\lambda,-}| \in \mathcal{A}_{\bar{\tau}}$. Choosing orthonormal

$$|\omega_{b',c',t',X'}^{\tau,\lambda,+}\rangle\langle\omega_{b,c,t,X}^{\tau,\lambda,+}| = \sum_{a,d} \begin{array}{c} \begin{array}{c} a \\ \downarrow \\ \begin{array}{c} c \\ \downarrow \\ X \\ \downarrow \\ t^* \end{array} \\ \downarrow \\ b \end{array} \\ \downarrow \\ \lambda \\ \begin{array}{c} \begin{array}{c} t' \\ \downarrow \\ (X')^* \\ \downarrow \\ c' \end{array} \\ \downarrow \\ d \end{array} \\ \downarrow \\ \tau \end{array}$$

Figure 8: The elements $|\omega_{b',c',t',X'}^{\tau,\lambda,+}\rangle\langle\omega_{b,c,t,X}^{\tau,\lambda,+}| \in \mathcal{A}_{\tau}$

bases of isometries $t_{b,\bar{c}}^{\lambda;i} \in \text{Hom}(\lambda, b\bar{c})$ and $X_{\bar{c},b}^{\tau;j} \in \text{Hom}(\tau, \bar{c}b)$ we sometimes abbreviate $\omega_{b,c,i,j}^{\tau,\lambda,\pm} = \omega_{b,c,t_{b,\bar{c}}^{\lambda;i},X_{\bar{c},b}^{\tau;j}}^{\tau,\lambda,\pm}$ and we also use the notation $\omega_{\xi}^{\tau,\lambda,\pm} = \omega_{b,c,i,j}^{\tau,\lambda,\pm}$ with some multi-index $\xi = (b, c, i, j)$. For vectors $\varphi_{\ell}^{\tau,\lambda,\pm} \in H_{\tau,\lambda}^{\pm}$ with expansions $\varphi_{\ell}^{\tau,\lambda,\pm} = \sum_{\xi} c_{\ell,\pm}^{\xi} \omega_{\xi}^{\tau,\lambda,\pm}$, $\ell = 1, 2$, we define elements $|\varphi_1^{\tau,\lambda,+}\rangle\langle\varphi_2^{\tau,\lambda,+}| \in \mathcal{A}_{\tau}$ and $|\varphi_1^{\tau,\lambda,-}\rangle\langle\varphi_2^{\tau,\lambda,-}| \in \mathcal{A}_{\bar{\tau}}$ by

$$|\varphi_1^{\tau,\lambda,\pm}\rangle\langle\varphi_2^{\tau,\lambda,\pm}| = \sum_{\xi,\xi'} c_{1,\pm}^{\xi} (c_{2,\pm}^{\xi'})^* |\omega_{\xi}^{\tau,\lambda,\pm}\rangle\langle\omega_{\xi'}^{\tau,\lambda,\pm}|, \quad (17)$$

and scalars $\langle\varphi_2^{\tau,\lambda,\pm}, \varphi_1^{\tau,\lambda,\pm}\rangle \in \mathbb{C}$ by

$$\begin{aligned} \langle\varphi_2^{\tau,\lambda,+}, \varphi_1^{\tau,\lambda,+}\rangle &= \frac{1}{d_{\lambda}} \psi_v^{\tau}(|\varphi_1^{\tau,\lambda,+}\rangle\langle\varphi_2^{\tau,\lambda,+}|), \\ \langle\varphi_2^{\tau,\lambda,-}, \varphi_1^{\tau,\lambda,-}\rangle &= \frac{1}{d_{\lambda}} \psi_v^{\bar{\tau}}(|\varphi_1^{\tau,\lambda,-}\rangle\langle\varphi_2^{\tau,\lambda,-}|). \end{aligned} \quad (18)$$

Analogous to the proof of [4, Lemma 6.1] one checks that Eq. (17) extends to positive definite sesqui-linear maps $H_{\tau,\lambda}^+ \times H_{\tau,\lambda}^+ \rightarrow \mathcal{A}_{\tau}$ and $H_{\tau,\lambda}^- \times H_{\tau,\lambda}^- \rightarrow \mathcal{A}_{\bar{\tau}}$. Consequently, Eq. (18) defines scalar products turning $H_{\tau,\lambda}^{\pm}$ into Hilbert spaces. Note that the scalar product $\langle\omega_{b,c,t,X}^{\tau,\lambda,+}, \omega_{b',c',t',X'}^{\tau,\lambda,+}\rangle$ is given graphically as in Fig. 9. Here we pulled out a closed wire a so that the summation over a produced together with the prefactor d_a just the global index w . We define subspaces $A_{\tau,\lambda}^+ \subset \mathcal{A}_{\tau}$ respectively $A_{\tau,\lambda}^- \subset \mathcal{A}_{\bar{\tau}}$ given as the linear span of elements $|\omega_{b',c',t',X'}^{\tau,\lambda,+}\rangle\langle\omega_{b,c,t,X}^{\tau,\lambda,+}|$ respectively $|\omega_{b',c',t',X'}^{\tau,\lambda,-}\rangle\langle\omega_{b,c,t,X}^{\tau,\lambda,-}|$.

Lemma 3.5 *We have the identity of Fig. 10 for intertwiners in $\text{Hom}(\lambda', \lambda)$. An analogous identity can be established using vectors $\omega_{b,c,t,X}^{\tau,\lambda,-} \in H_{\tau,\lambda}^-$.*

$$\langle \omega_{b,c,t,X}^{\tau,\lambda,+}, \omega_{b',c',t',X'}^{\tau,\lambda,+} \rangle = \frac{w}{d_\lambda}$$

Figure 9: The scalar product $\langle \omega_{b,c,t,X}^{\tau,\lambda,+}, \omega_{b',c',t',X'}^{\tau,\lambda,+} \rangle$

$$\sum_a d_a$$

$$= \delta_{\lambda,\lambda'} \langle \omega_{b,c,t,X}^{\tau,\lambda,+}, \omega_{b',c',t',X'}^{\tau,\lambda,+} \rangle$$

Figure 10: An identity in $\text{Hom}(\lambda', \lambda)$

Proof. (Similar to the proof of [4, Lemma 6.2].) It is clear that we obtain a scalar which is zero unless $\lambda = \lambda'$. To compute the scalar, we put $\lambda = \lambda'$ and then we can close the wire λ on the left hand side, what has to be compensated by a factor $1/d_\lambda$. We can now open the wire a on the right and close it on the left, and this way we can pull out the wire a , yielding a closed loop. Hence the summation over a gives the global index, and the resulting picture is regularly isotopic to Fig. 9. \square

Corollary 3.6 *The subspaces $A_{\tau,\lambda}^+ \subset \mathcal{A}_\tau$ and $A_{\tau,\lambda}^- \subset \mathcal{A}_{\bar{\tau}}$ are in fact subalgebras. Moreover, in \mathcal{A}_τ respectively $\mathcal{A}_{\bar{\tau}}$ we have multiplication rules*

$$|\varphi_1^{\tau,\lambda,\pm}\rangle\langle\varphi_2^{\tau,\lambda,\pm}| \star_v |\varphi_3^{\tau,\mu,\pm}\rangle\langle\varphi_4^{\tau,\mu,\pm}| = \delta_{\lambda,\mu} \langle\varphi_2^{\tau,\lambda,\pm}, \varphi_3^{\tau,\lambda,\pm}\rangle |\varphi_1^{\tau,\lambda,\pm}\rangle\langle\varphi_4^{\tau,\lambda,\pm}|, \quad (19)$$

$\varphi_\ell^{\tau,\lambda,\pm} \in H_{\tau,\lambda}^\pm$, $\ell = 1, 2, 3, 4$. Consequently, we have subalgebras $A_\tau^+ \subset \mathcal{A}_\tau$ and $A_{\bar{\tau}}^- \subset \mathcal{A}_{\bar{\tau}}$ given as the direct sums $A_\tau^\pm = \bigoplus_\lambda A_{\tau,\lambda}^\pm$. We can choose orthonormal bases $\{u_i^{\tau,\lambda,\pm}\}_{i=1}^{\dim H_{\tau,\lambda}^\pm}$ of $H_{\tau,\lambda}^\pm$ to obtain systems of matrix units $\{|u_i^{\tau,\lambda,\pm}\rangle\langle u_j^{\tau,\lambda,\pm}|\}_{\lambda,i,j}$ in A_τ^\pm .

We call the algebras A_τ^\pm , $\tau \in {}_M\mathcal{X}_M^0$, *chiral vertical algebras*. Next we define elements $I_\tau^+ \in \mathcal{A}_\tau$ and $I_\tau^- \in \mathcal{A}_{\bar{\tau}}$ by the diagrams in Fig. 11 and we call them *chiral multiplicative units* (for reasons given below). We then claim the following

$$I_\tau^+ = \frac{1}{w_+} \sum_{\beta \in {}_M\mathcal{X}_M^-} \sum_{a,b} \begin{array}{c} a \\ | \\ \leftarrow \beta \\ | \\ \tau \\ | \\ b \end{array} \quad I_\tau^- = \frac{1}{w_+} \sum_{\beta \in {}_M\mathcal{X}_M^+} \sum_{a,b} \begin{array}{c} a \\ | \\ \tau \\ | \\ \beta \\ | \\ b \end{array}$$

Figure 11: Chiral multiplicative units I_τ^\pm

Lemma 3.7 *We have*

$$I_\tau^\pm = \frac{1}{w^2 \sqrt{d_\tau}} \sum_{\lambda, \xi} \sqrt{d_\lambda} |\omega_\xi^{\tau, \lambda, \pm}\rangle \langle \omega_\xi^{\tau, \lambda, \pm}|. \quad (20)$$

Proof. We compute the sum

$$\sum_{\lambda, b, c, i, j} \frac{\sqrt{d_\lambda}}{w^2 \sqrt{d_\tau}} |\omega_{b, c, i, j}^{\tau, \lambda, +}\rangle \langle \omega_{b, c, i, j}^{\tau, \lambda, +}|$$

graphically. The proof for “−” is analogous. This sum is given by the left hand side of Fig. 12. Using the expansion of the identity (cf. [4, Lemma 4.3]) for the parallel

$$\sum_{a, b, c, d, \lambda, j} \frac{\sqrt{d_b d_c}}{w^2 \sqrt{d_\tau}} \begin{array}{c} a \\ | \\ \text{---} X_{\bar{c}, b}^{\tau; j} \text{---} \\ | \\ \lambda \\ | \\ \text{---} (X_{\bar{c}, b}^{\tau; j})^* \text{---} \\ | \\ d \end{array} = \sum_{a, b, c, d, \lambda, \nu, \rho, j} \frac{\sqrt{d_b d_c}}{w^2 \sqrt{d_\tau}} \begin{array}{c} a \\ | \\ \text{---} X_{\bar{c}, b}^{\tau; j} \text{---} \\ | \\ \nu \\ | \\ \text{---} (X_{\bar{c}, b}^{\tau; j})^* \text{---} \\ | \\ \rho \\ | \\ d \end{array}$$

Figure 12: The sum $\sum_{\lambda, \xi} w^{-2} \sqrt{d_\lambda / d_\tau} |\omega_\xi^{\tau, \lambda, \pm}\rangle \langle \omega_\xi^{\tau, \lambda, \pm}|$

wires a, b on the top and d, b on the bottom we obtain the right hand side of Fig. 12. Using such an expansion now the other way round for the summation over λ we arrive at the left hand side of Fig. 13. The crucial point is now the observation that left and right part of this wire diagram are only connected by wires α_ν^- and α_ρ^- . Let us

$$\sum_{\substack{a,b,c,d, \\ \nu,\rho,j}} \frac{\sqrt{d_b d_c}}{w^2 \sqrt{d_\tau}}
\begin{array}{c}
a \\
\downarrow \\
\text{---} \\
\uparrow \\
b \\
\downarrow \\
\text{---} \\
\uparrow \\
c \\
\downarrow \\
\text{---} \\
\uparrow \\
b \\
\downarrow \\
\text{---} \\
\uparrow \\
d \\
\downarrow \\
\tau
\end{array}
= \sum_{\substack{a,b,c,d,\lambda,j, \\ \beta \in {}_M\mathcal{X}_M^-}} \frac{\sqrt{d_b d_c}}{w^2 \sqrt{d_\tau}}
\begin{array}{c}
a \\
\downarrow \\
c \\
\downarrow \\
\text{---} \\
\uparrow \\
b \\
\downarrow \\
\text{---} \\
\uparrow \\
\beta \\
\downarrow \\
\text{---} \\
\uparrow \\
\lambda \\
\downarrow \\
\text{---} \\
\uparrow \\
c \\
\downarrow \\
\text{---} \\
\uparrow \\
d \\
\downarrow \\
\tau
\end{array}$$

Figure 13: The sum $\sum_{\lambda,\xi} w^{-2} \sqrt{d_\lambda/d_\tau} |\omega_\xi^{\tau,\lambda,\pm}\rangle \langle \omega_\xi^{\tau,\lambda,\pm}|$

start again with the original picture, namely the left hand side of Fig. 12, and make an expansion for the open ending wires a and d on the left side with a summation over wires $\beta \in {}_M\mathcal{X}_M$. Then it follows that only the wires with $\beta \in {}_M\mathcal{X}_M^-$ contribute because $\text{Hom}(\beta, \alpha_\rho^- \alpha_\nu^-)$ is always zero unless $\beta \in {}_M\mathcal{X}_M^-$. This establishes equality with the right hand side of Fig. 13. The wire β can now be pulled in and application of the naturality move (cf. Fig. 1) for the relative braiding yields the left hand side of Fig. 14. Then, using the graphical identity of Fig. 2 gives us the right hand side

$$\sum_{\substack{a,b,c,d,\lambda,j, \\ \beta \in {}_M\mathcal{X}_M^-}} \frac{\sqrt{d_b d_c}}{w^2 \sqrt{d_\tau}}
\begin{array}{c}
a \\
\downarrow \\
c \\
\downarrow \\
\text{---} \\
\uparrow \\
b \\
\downarrow \\
\text{---} \\
\uparrow \\
\alpha_\lambda^+ \\
\downarrow \\
\text{---} \\
\uparrow \\
b \\
\downarrow \\
\text{---} \\
\uparrow \\
c \\
\downarrow \\
\text{---} \\
\uparrow \\
d \\
\downarrow \\
\beta \\
\downarrow \\
\tau
\end{array}
= \sum_{\substack{a,b,c,d,j, \\ \beta \in {}_M\mathcal{X}_M^-}} \frac{\sqrt{d_b d_c}}{w w_+ \sqrt{d_\tau}}
\begin{array}{c}
a \\
\downarrow \\
c \\
\downarrow \\
\text{---} \\
\uparrow \\
b \\
\downarrow \\
\text{---} \\
\uparrow \\
\tau \\
\downarrow \\
\text{---} \\
\uparrow \\
c \\
\downarrow \\
\text{---} \\
\uparrow \\
d \\
\downarrow \\
\beta \\
\downarrow \\
\tau
\end{array}$$

Figure 14: The sum $\sum_{\lambda,\xi} w^{-2} \sqrt{d_\lambda/d_\tau} |\omega_\xi^{\tau,\lambda,\pm}\rangle \langle \omega_\xi^{\tau,\lambda,\pm}|$

of Fig. 14, as only the wire τ survives in the sum of the chiral horizontal projector. The two “bulbs” yield just a scalar factor $\sqrt{d_b d_c/d_\tau}$, but due to the summation over the fusion channels j it appears with multiplicity $N_{\bar{c},b}^\tau$. Hence the total prefactor is

calculated as

$$\sum_{b,c} \frac{d_b d_c N_{c,b}^\tau}{w w_+ d_\tau} = \sum_b \frac{d_b^2}{w w_+} = \frac{1}{w_+},$$

and this is the prefactor of I_τ^+ . \square

Now let us consider the case $\tau = \text{id}$: Note that \mathcal{A}_{id} is a subspace of the double triangle algebra \diamond containing the horizontal center \mathcal{Z}_h . Then the sum $\frac{1}{w^2} \sum_{\lambda,\xi} \sqrt{d_\lambda} |\omega_\xi^{0,\lambda,\pm}\rangle \langle \omega_\xi^{0,\lambda,\pm}|$ gives graphically exactly the picture (+) for $\sum_\lambda q_{\lambda,0}$ respectively (-) for $\sum_\lambda q_{0,\lambda}$, where $q_{\lambda,\mu} \in \mathcal{Z}_h$ are the vertical projectors of [4, Def. 6.7]. Hence we obtain the following

Corollary 3.8 *In the double triangle algebra we have $w_+ \sum_\lambda q_{\lambda,0} = P^-$ and $w_+ \sum_\lambda q_{0,\lambda} = P^+$.*

Next we establish some kind of trivial action of ${}_M \mathcal{X}_M^\pm$ on $H_{\tau,\lambda}^\mp$.

Lemma 3.9 *For $\beta \in {}_M \mathcal{X}_M^-$ we have the identity of Fig. 15. An analogous identity holds when we choose $\beta \in {}_M \mathcal{X}_M^+$ acting on $\omega_{b,c,t,X}^{\tau,\lambda,-}$.*

$$\sum_{a,d} d_a \text{ (diagram) } = d_\beta^2 \omega_{b,c,t,X}^{\tau,\lambda,+}$$

Figure 15: The trivial action of ${}_M \mathcal{X}_M^-$ on $H_{\tau,\lambda}^+$

Proof. Starting with Fig. 15 we can slide around the, say, left trivalent vertex of the wire β to obtain the left hand side of Fig. 16. Using now naturality move for the relative braiding and turning around the small arcs, giving a factor d_β/d_a , yields the right hand side of Fig. 16. We now see that the summation over the wire a is just an expansion of the identity which can be replaced by parallel wires β and d (cf. [4, Lemma 4.3]). Hence we obtain a closed loop β which is just another factor d_β , and we are left with the original diagram for $\omega_{b,c,t,X}^{\tau,\lambda,+}$, together with a prefactor d_β^2 . \square

We now obtain immediately the following corollary which finally justifies the name “chiral multiplicative units” for elements $I_\tau^\pm \in A_\tau^\pm$.

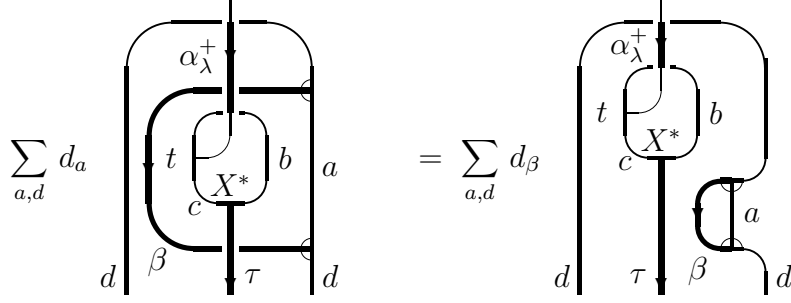

Figure 16: Proof of the trivial action of $M\mathcal{X}_M^-$ on $H_{\tau,\lambda}^+$

Corollary 3.10 *In \mathcal{A}_τ we have*

$$I_\tau^\pm \star_v |\omega_{b',c',t',X'}^{\tau,\lambda,\pm}\rangle \langle \omega_{b,c,t,X}^{\tau,\lambda,\pm}| = |\omega_{b',c',t',X'}^{\tau,\lambda,\pm}\rangle \langle \omega_{b,c,t,X}^{\tau,\lambda,\pm}| \star_v I_\tau^\pm = |\omega_{b',c',t',X'}^{\tau,\lambda,\pm}\rangle \langle \omega_{b,c,t,X}^{\tau,\lambda,\pm}|. \quad (21)$$

Then we define elements $I_{\tau,\lambda}^\pm \in A_{\tau,\lambda}^\pm$ by

$$I_{\tau,\lambda}^\pm = \frac{1}{w^2} \sqrt{\frac{d_\lambda}{d_\tau}} \sum_\xi |\omega_\xi^{\tau,\lambda,\pm}\rangle \langle \omega_\xi^{\tau,\lambda,\pm}|, \quad (22)$$

so that $I_\tau^\pm = \sum_\lambda I_{\tau,\lambda}^\pm$. We now claim

Lemma 3.11 *We have the expansion in matrix units*

$$I_{\tau,\lambda}^\pm = \sum_{i=1}^{\dim H_{\tau,\lambda}^\pm} |u_i^{\tau,\lambda,\pm}\rangle \langle u_i^{\tau,\lambda,\pm}|. \quad (23)$$

Proof. Using Lemma 3.7, Corollary 3.6 and Corollary 3.10 we compute

$$\begin{aligned} \frac{1}{w^2} \sqrt{\frac{d_\lambda}{d_\tau}} \sum_\xi \langle u_i^{\tau,\lambda,\pm}, \omega_\xi^{\tau,\lambda,\pm} \rangle \langle \omega_\xi^{\tau,\lambda,\pm}, u_j^{\tau,\lambda,\pm} | u_i^{\tau,\lambda,\pm} \rangle \langle u_j^{\tau,\lambda,\pm} | &= \\ = |u_i^{\tau,\lambda,\pm}\rangle \langle u_i^{\tau,\lambda,\pm}| \star_v I_\tau^\pm \star_v |u_j^{\tau,\lambda,\pm}\rangle \langle u_j^{\tau,\lambda,\pm}| &= \delta_{i,j} |u_i^{\tau,\lambda,\pm}\rangle \langle u_i^{\tau,\lambda,\pm}|. \end{aligned}$$

On the other hand we obtain by expanding the vectors $\omega_\xi^{\tau,\lambda,\pm}$ in basis vectors $u_i^{\tau,\lambda,\pm}$

$$I_{\tau,\lambda}^\pm = \frac{1}{w^2} \sqrt{\frac{d_\lambda}{d_\tau}} \sum_{\xi,i,j} \langle u_i^{\tau,\lambda,\pm}, \omega_\xi^{\tau,\lambda,\pm} \rangle \langle \omega_\xi^{\tau,\lambda,\pm}, u_j^{\tau,\lambda,\pm} | u_i^{\tau,\lambda,\pm} \rangle \langle u_j^{\tau,\lambda,\pm} |,$$

hence $I_{\tau,\lambda}^\pm = \sum_{i,j} \delta_{i,j} |u_i^{\tau,\lambda,\pm}\rangle \langle u_i^{\tau,\lambda,\pm}|$. □

Lemma 3.12 *The dimensions of the Hilbert spaces $H_{\tau,\lambda}^\pm$ are given by the chiral branching coefficients: $\dim H_{\tau,\lambda}^\pm = b_{\tau,\lambda}^\pm$.*

Proof. We show $\dim H_{\tau,\lambda}^+ = b_{\tau,\lambda}^+$; the “-” case is analogous. The dimensions $\dim H_{\tau,\lambda}^+$ are counted as

$$\dim H_{\tau,\lambda}^+ = \sum_{i=1}^{\dim H_{\tau,\lambda}^+} \langle u_i^{\tau,\lambda,+}, u_i^{\tau,\lambda,+} \rangle = \frac{1}{d_\lambda} \psi_v^\tau(I_{\tau,\lambda}^+) = \frac{1}{w^2} \sqrt{\frac{d_\lambda}{d_\tau}} \sum_\xi \langle \omega_\xi^{\tau,\lambda,+}, \omega_\xi^{\tau,\lambda,+} \rangle.$$

Using now the graphical representation of the scalar product in Fig. 9, then we obtain with the normalization convention for the small semicircular wires exactly the wire diagram for $b_{\tau,\lambda}^+$, cf. Fig. 3. \square

3.4 Chiral representations

Recall that the horizontal center \mathcal{Z}_h of the double triangle algebra \diamond is spanned by the elements e_β with $\beta \in {}_M\mathcal{X}_M$. Denote $\mathcal{Z}_h^\pm = P^\pm *_h \mathcal{Z}_h$. Since the e_β 's are projections with respect to the horizontal product, $\mathcal{Z}_h^\pm \subset \mathcal{Z}_h$ are the subspaces spanned by elements e_{β_\pm} with $\beta_\pm \in {}_M\mathcal{X}_M^\pm$. As $(\mathcal{Z}_h, *_v)$ is isomorphic to the M - M fusion rule algebra (cf. [4, Thm. 4.4]) and since ${}_M\mathcal{X}_M^\pm \subset {}_M\mathcal{X}_M$ are subsystems, $\mathcal{Z}_h^\pm \subset \mathcal{Z}_h$ are in fact vertical subalgebras. We are now going to construct representations of these chiral vertical algebras $(\mathcal{Z}_h^\pm, *_v)$.

Lemma 3.13 *For $\beta_\pm \in {}_M\mathcal{X}_M^\pm$ let $\pi_{\tau,\lambda}^+(e_{\beta_+})\omega_{b,c,t,X}^{\tau,\lambda,+} \in \mathcal{H}_{\tau,\lambda}$ and $\pi_{\tau,\lambda}^-(e_{\beta_-})\omega_{b,c,t,X}^{\tau,\lambda,-} \in \mathcal{H}_{\bar{\tau},\bar{\lambda}}$, respectively, denote the vectors defined graphically by the left respectively right hand side of Fig. 17. Then in fact $\pi_{\tau,\lambda}^\pm(e_{\beta_\pm})\omega_{b,c,t,X}^{\tau,\lambda,\pm} \in H_{\tau,\lambda}^\pm$.*

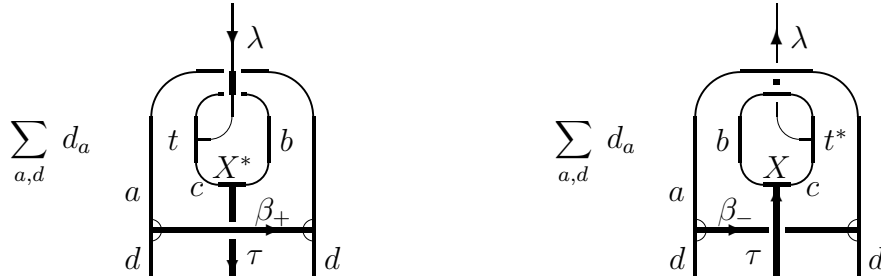

Figure 17: The vectors $\pi_{\tau,\lambda}^+(e_{\beta_+})\omega_{b,c,t,X}^{\tau,\lambda,+} \in \mathcal{H}_{\tau,\lambda}$ and $\pi_{\tau,\lambda}^-(e_{\beta_-})\omega_{b,c,t,X}^{\tau,\lambda,-} \in \mathcal{H}_{\bar{\tau},\bar{\lambda}}$

Proof. We prove $\pi_{\tau,\lambda}^+(e_{\beta_+})\omega_{b,c,t,X}^{\tau,\lambda,+} \in H_{\tau,\lambda}^+$ for $\beta_+ \in {}_M\mathcal{X}_M^+$. The proof of $\pi_{\tau,\lambda}^-(e_{\beta_-})\omega_{b,c,t,X}^{\tau,\lambda,-} \in H_{\bar{\tau},\bar{\lambda}}$ for $\beta_- \in {}_M\mathcal{X}_M^-$ is analogous. First we can turn around the small arcs at the trivalent vertices of the wire β_+ which gives us a factor d_{β_+}/d_a . Then we use the expansion of the identity (cf. [4, Lemma 4.3]) for the parallel wires a and b . This way we obtain the left hand side of Fig. 18. Now let us look at the part of the picture above the dotted line. In a suitable Frobenius annulus, this part can be

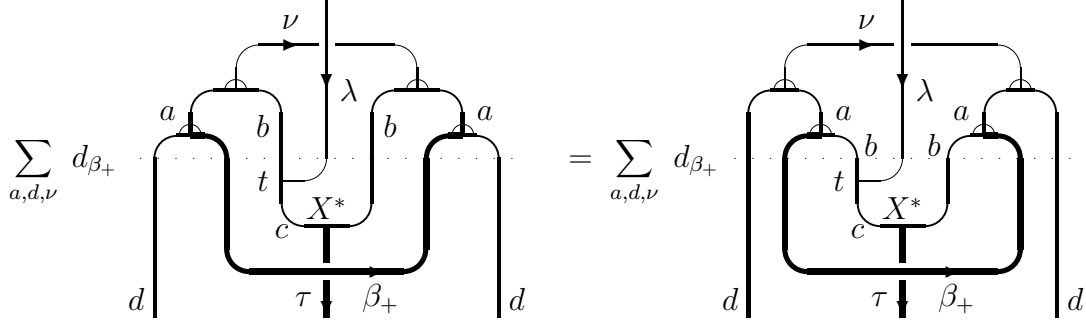

Figure 18: The vector $\pi_{\tau, \lambda}^+(e_{\beta_+})\omega_{b, c, t, X}^{\tau, \lambda, +} \in \mathcal{H}_{\tau, \lambda}$

read for fixed ν and d as $\sum_i \lambda(t_i)\varepsilon^-(\nu, \lambda)t_i^*$, and the sum runs over a full orthonormal basis of isometries $t_i \in \text{Hom}(\nu, b\bar{\beta}_+d)$. Next we look at the part above the dotted line on the right hand side of Fig. 18. In the same Frobenius annulus, this can be similarly read as $\sum_j \lambda(s_j)\varepsilon^-(\nu, \lambda)s_j^*$ where the sum runs over another orthonormal basis of isometries $s_j \in \text{Hom}(\nu, b\bar{\beta}_+d)$. Since such bases are related by a unitary matrix (“unitarity of 6j-symbols”), we conclude that both diagrams represent the same vector in $\mathcal{H}_{\tau, \lambda}$. Now turning around the small arcs at the trivalent vertices of the wire β_+ and using the expansion the identity in the reverse way leads us to the left hand side of Fig. 19. Then we look at the part of the picture inside the dotted box. In a

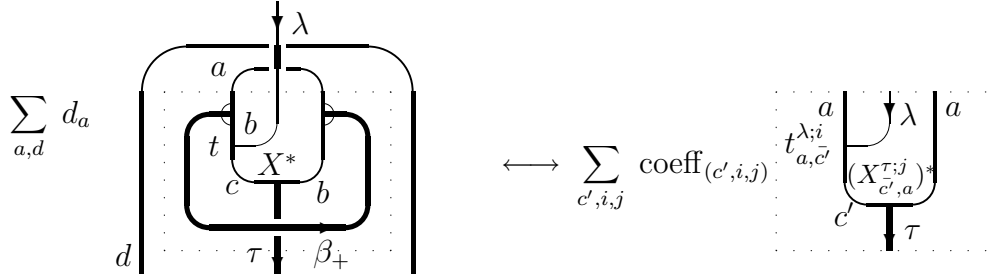

Figure 19: The vector $\pi_{\tau, \lambda}^+(e_{\beta_+})\omega_{b, c, t, X}^{\tau, \lambda, +} \in \mathcal{H}_{\tau, \lambda}$

suitable Frobenius annulus, this can be read as an intertwiner in $\text{Hom}(\bar{a}\lambda, \tau\bar{a})$. Since any element in this space can be expanded in the basis given in the dotted box on the right hand side of Fig. 19, we conclude that $\pi_{\tau, \lambda}^+(e_{\beta_+})\omega_{b, c, t, X}^{\tau, \lambda, +}$ is in fact a linear combination of $\omega_{\xi}^{\tau, \lambda, +}$'s, hence it is in $H_{\tau, \lambda}^+$. \square

Since it is just intertwiner multiplication in each $\text{Hom}(\lambda, a\tau\bar{a})$ block, the prescription $\omega_{b, c, t, X}^{\tau, \lambda, +} \mapsto \pi_{\tau, \lambda}^+(e_{\beta_+})\omega_{b, c, t, X}^{\tau, \lambda, +}$ clearly defines a linear map $\pi_{\tau, \lambda}^+(e_{\beta_+}) : H_{\tau, \lambda}^+ \mapsto \mathcal{H}_{\tau, \lambda}$ for each $\beta_+ \in {}_M\mathcal{X}_M^+$. From Lemma 3.13 we now learn that $\pi_{\tau, \lambda}^+(e_{\beta_+})$ is in fact a

linear operator on $H_{\tau,\lambda}^+$. Similarly $\pi_{\tau,\lambda}^-(e_{\beta_-})$ is a linear operator on $H_{\tau,\lambda}^-$ for each $\beta_- \in {}_M\mathcal{X}_M^-$. We therefore obtain linear maps $\pi_{\tau,\lambda}^\pm : \mathcal{Z}_h^\pm \rightarrow B(H_{\tau,\lambda}^\pm)$ by linear extension of $e_{\beta_\pm} \mapsto \pi_{\tau,\lambda}^\pm(e_{\beta_\pm})$, $\beta_\pm \in {}_M\mathcal{X}_M^\pm$.

Lemma 3.14 *The maps $\pi_{\tau,\lambda}^\pm : \mathcal{Z}_h^\pm \rightarrow B(H_{\tau,\lambda}^\pm)$ are in fact linear representations.*

Proof. We prove the representation property of $\pi_{\tau,\lambda}^+$; the proof for $\pi_{\tau,\lambda}^-$ is analogous. For $\beta_+, \beta'_+ \in {}_M\mathcal{X}_M^+$, the vector $\pi_{\tau,\lambda}^+(e_{\beta_+})(\pi_{\tau,\lambda}^+(e_{\beta'_+})\omega_{b,c,t,X}^{\tau,\lambda,+})$ is given graphically by the left hand side of Fig. 20. Next we use the expansion of the identity (cf. [4, Lemma

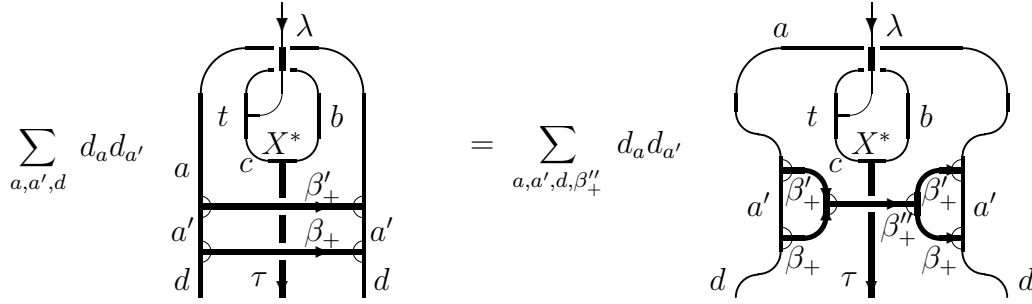

Figure 20: The vector $\pi_{\tau,\lambda}^+(e_{\beta_+})\pi_{\tau,\lambda}^+(e_{\beta'_+})\omega_{b,c,t,X}^{\tau,\lambda,+} \in H_{\tau,\lambda}^+$

4.3]) for the parallel wires β_+ and β'_+ on, say, the left hand side of the crossings with the wire τ . Note that only $\beta''_+ \in {}_M\mathcal{X}_M^+$ can contribute because $\text{Hom}(\beta_+\beta'_+, \beta''_+) = 0$ otherwise. Application of the braiding fusion relation for the relative braiding yields the right hand side of Fig. 20. Using expansions of the identity also for the parallel pieces of the wires a and d on the left and on the right, we obtain a picture where the bottom part coincides with the wire diagram in [4, Fig. 42], up to the crossing with the wire τ . In fact we can use the same argument (“unitarity of 6j-symbols”) as in the proof of [4, Thm. 4.4] to obtain the desired result

$$\pi_{\tau,\lambda}^+(e_{\beta_+})(\pi_{\tau,\lambda}^+(e_{\beta'_+})\omega_{b,c,t,X}^{\tau,\lambda,+}) = \sum_{\beta''_+ \in {}_M\mathcal{X}_M^+} \frac{d_{\beta_+}d_{\beta'_+}}{d_{\beta''_+}} N_{\beta_+, \beta'_+}^{\beta''_+} \pi_{\tau,\lambda}^+(e_{\beta''_+})\omega_{b,c,t,X}^{\tau,\lambda,+}.$$

As the prefactors coincide with those in the decomposition of the vertical product $e_{\beta_+} *_v e_{\beta'_+}$ into $e_{\beta''_+}$ ’s, the claim is proven. \square

4 Chiral structure of the center \mathcal{Z}_h

In this section we will analyze the chiral systems ${}_M\mathcal{X}_M^\pm$ in the non-degenerate case, i.e. from now on we impose the following

Assumption 4.1 In addition to Assumption 2.4, we now assume that the braiding on ${}_N\mathcal{X}_N$ is non-degenerate in the sense of [4, Def. 2.3].

4.1 Non-degeneracy of the ambichiral braiding

We define $w_0 = \sum_{\beta \in {}_M\mathcal{X}_M^0} d_\beta^2$ and call it the *ambichiral global index*.

Theorem 4.2 *The braiding on the ambichiral system ${}_M\mathcal{X}_M^0$ arising from the relative braiding of the chiral systems is non-degenerate. Moreover, the ambichiral global index is given by $w_0 = w_+^2/w$.*

Proof. From Lemma [4, Thm. 6.8] we obtain $\sum_{\lambda,\mu} q_{\lambda,\mu} *_h e_\tau = \delta_{\tau,0} e_0$. The left hand side is displayed graphically by the left hand side of Fig. 21. We can “pull in”

Figure 21: Non-degeneracy of the ambichiral braiding

the wire τ since it admits relative braiding with both α_λ^+ and α_μ^- , and this way we obtain the right hand side of Fig. 21. We can use the expansion of the identity for the parallel wires b, c on the top and bottom (cf. [4, Lemma 4.3]) to obtain the left hand side of Fig. 22. Here only ambichiral morphisms $\tau, \tau' \in {}_M\mathcal{X}_M^0$ contribute in

Figure 22: Non-degeneracy of the ambichiral braiding

the corresponding sums over $\beta', \beta'' \in {}_M\mathcal{X}_M$ since they appear between α_λ^+ and α_μ^- . Application of the naturality moves for the relative braiding yields the right hand side of Fig. 22. Now we see that intertwiners in $\text{Hom}(\tau', \tau'')$ appear so that we first obtain a factor $\delta_{\tau', \tau''}$. Then we take the scalar part of the loop separately to obtain Fig. 23, where we need a compensating factor $1/d_{\tau'}$. By using the (+ and - version of the) graphical identity of Fig. 2 we obtain the left hand side of Fig. 24. Here we

$$\sum_{a,b,c,d,\lambda,\mu,\tau'} \frac{d_b d_c}{w^2 d_{\tau'}} \alpha_{\lambda}^+ \alpha_{\mu}^-$$

Figure 23: Non-degeneracy of the ambichiral braiding

$$\sum_{a,b,c,d,\tau'} \frac{d_b d_c}{w_+^2 d_{\tau'}} \alpha_{\lambda}^+ \alpha_{\mu}^-$$

Figure 24: Non-degeneracy of the ambichiral braiding

used the fact that only the wire τ' survives the summations over $\beta \in {}_M \mathcal{X}_M^{\pm}$ of the chiral horizontal projectors. The “bulbs” give just inner products of basis isometries. Due to the summation over internal fusion channels we obtain therefore a multiplicity $N_{\bar{c},b}^{\tau'}$ with a closed wire τ' , evaluated as $d_{\tau'}$. Thus we are left with the right hand side of Fig. 24. Note that $\sum_{b,c} d_b d_c N_{\bar{c},b}^{\tau'} = \sum_b d_b^2 d_{\tau'} = w d_{\tau'}$. Now the $\text{Hom}(a\bar{a}, d\bar{d})$ part of the right hand side of Fig. 24 must be equal to the $\text{Hom}(a\bar{a}, d\bar{d})$ part of $\delta_{\tau,0} e_0$. Sandwiching this with basis (co-) isometries yields the identity displayed in Fig. 25. This is the orthogonality relation showing that the braiding on the ambichiral system

$$\sum_{\tau'} d_{\tau'} \text{---} \bigcirc_{\tau'} \text{---} = \delta_{\tau,0} \frac{w_+^2}{w}$$

Figure 25: Non-degeneracy of the ambichiral braiding

is non-degenerate (cf. [4, Fig. 20]). Consequently the number w_+^2/w must be w_0 , the ambichiral global index. \square

Let us define scalars $\omega_\tau, Y_{\tau,\tau'}^{\text{ext}} \in \mathbb{C}$ by

$$R_\tau^* \mathcal{E}_\tau(\bar{\tau}, \tau)^* \bar{R}_\tau = \omega_\tau \mathbf{1}, \quad d_\tau d_{\tau'} \phi_\tau(\mathcal{E}_\tau(\tau', \tau) \mathcal{E}_\tau(\tau, \tau'))^* = Y_{\tau,\tau'}^{\text{ext}} \mathbf{1},$$

for $\tau, \tau' \in {}_M \mathcal{X}_M^0$. Note that these numbers can be displayed graphically as in Fig. 26.

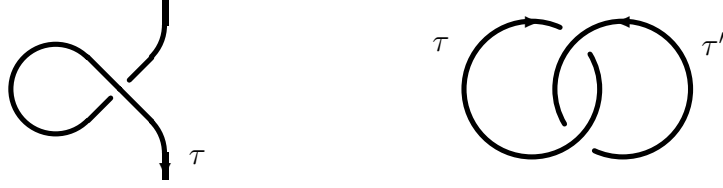

Figure 26: Statistics phase ω_τ and Y-matrix element $Y_{\tau,\tau'}^{\text{ext}}$ for the ambichiral system

Putting also $c_0 = 4\arg(\sum_{\tau \in {}_M \mathcal{X}_M^0} d_\tau^2 \omega_\tau) / \pi$ we obtain from Theorem 4.2 the following

Corollary 4.3 *Matrices S^{ext} and T^{ext} with matrix elements $S_{\tau,\tau'}^{\text{ext}} = w_0^{-1/2} Y_{\tau,\tau'}^{\text{ext}}$ and $T_{\tau,\tau'}^{\text{ext}} = e^{-\pi i c_0 / 12} \omega_\tau \delta_{\tau,\tau'}$, $\tau, \tau' \in {}_M \mathcal{X}_M^0$, obey the full Verlinde modular algebra and diagonalize the fusion rules of the ambichiral system.*

4.2 Chiral matrix units

For elements $|\omega_{b_1, c_1, t_1, X_1}^{\tau, \lambda, +}\rangle \langle \omega_{b_2, c_2, t_2, X_2}^{\tau, \lambda, +}| \in A_{\tau, \lambda}^+$ and $|\omega_{b_3, c_3, t_3, X_3}^{\tau, \mu, -}\rangle \langle \omega_{b_4, c_4, t_4, X_4}^{\tau, \mu, -}| \in A_{\tau, \mu}^-$ we define an element $|\omega_{b_1, c_1, t_1, X_1}^{\tau, \lambda, +}\rangle \langle \omega_{b_2, c_2, t_2, X_2}^{\tau, \lambda, +}| \otimes |\omega_{b_3, c_3, t_3, X_3}^{\tau, \mu, -}\rangle \langle \omega_{b_4, c_4, t_4, X_4}^{\tau, \mu, -}|$ in the double triangle algebra by the diagram in Fig. 27. Then, for elements

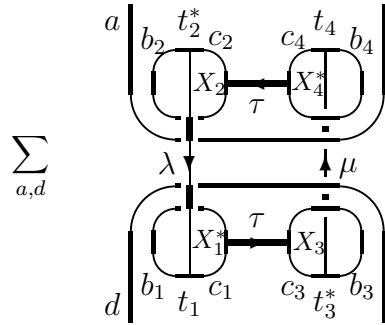

Figure 27: The element $|\omega_{b_1, c_1, t_1, X_1}^{\tau, \lambda, +}\rangle \langle \omega_{b_2, c_2, t_2, X_2}^{\tau, \lambda, +}| \otimes |\omega_{b_3, c_3, t_3, X_3}^{\tau, \mu, -}\rangle \langle \omega_{b_4, c_4, t_4, X_4}^{\tau, \mu, -}| \in \diamond$

$$|\varphi_1^{\tau, \lambda, +}\rangle \langle \varphi_2^{\tau, \lambda, +}| = \sum_{\xi, \xi'} c_{1,+}^\xi (c_{2,+}^{\xi'})^* |\omega_\xi^{\tau, \lambda, +}\rangle \langle \omega_{\xi'}^{\tau, \lambda, +}| \in A_{\tau, \lambda}^+$$

and

$$|\varphi_3^{\tau,\mu,-}\rangle\langle\varphi_4^{\tau,\mu,-}| = \sum_{\xi,\xi'} c_{3,-}^{\xi} (c_{4,-}^{\xi'})^* |\omega_{\xi}^{\tau,\mu,-}\rangle\langle\omega_{\xi'}^{\tau,\mu,-}| \in A_{\tau,\mu}^-$$

we define an element $|\varphi_1^{\tau,\lambda,+}\rangle\langle\varphi_2^{\tau,\lambda,+}| \otimes |\varphi_3^{\tau,\mu,-}\rangle\langle\varphi_4^{\tau,\mu,-}| \in \diamond$ by putting

$$\begin{aligned} & |\varphi_1^{\tau,\lambda,+}\rangle\langle\varphi_2^{\tau,\lambda,+}| \otimes |\varphi_3^{\tau,\mu,-}\rangle\langle\varphi_4^{\tau,\mu,-}| = \\ & \sum_{\xi,\xi',\xi'',\xi'''} c_{1,+}^{\xi} (c_{2,+}^{\xi'})^* c_{3,-}^{\xi''} (c_{4,-}^{\xi'''})^* |\omega_{\xi}^{\tau,\lambda,+}\rangle\langle\omega_{\xi'}^{\tau,\lambda,+}| \otimes |\omega_{\xi''}^{\tau,\mu,-}\rangle\langle\omega_{\xi'''}^{\tau,\mu,-}|. \end{aligned} \quad (24)$$

Lemma 4.4 *Eq. (24) extends to a bi-linear map $A_{\tau,\lambda}^+ \times A_{\tau,\mu}^- \rightarrow \mathcal{Z}_h$.*

Proof. Let $\Phi_{a,b}^+$ denote the $\text{Hom}(a\tau\bar{a}, b\tau\bar{b})$ part of $|\varphi_1^{\tau,\lambda,+}\rangle\langle\varphi_2^{\tau,\lambda,+}|$ and similarly $\Phi_{a,b}^-$ the $\text{Hom}(a\bar{\tau}\bar{a}, b\bar{\tau}\bar{b})$ part of $|\varphi_3^{\tau,\mu,-}\rangle\langle\varphi_4^{\tau,\mu,-}|$. Then the $\text{Hom}(a\bar{a}, \bar{b}\bar{b})$ part $\Phi_{a,b}$ of

$$\Phi = |\varphi_1^{\tau,\lambda,+}\rangle\langle\varphi_2^{\tau,\lambda,+}| \otimes |\varphi_3^{\tau,\mu,-}\rangle\langle\varphi_4^{\tau,\mu,-}| \in \diamond$$

can be written as

$$\Phi_{a,b} = d_{\tau} \sqrt{d_a d_b} b(\bar{R}_{\tau})^* b\tau(R_b)^* \Phi_{a,b}^+ a\tau\bar{a}(\Phi_{a,b}^-) a\tau(R_a) a(\bar{R}_{\tau}).$$

Thus each component of Φ is obviously linear in the components of the vectors in $A_{\tau,\lambda}^+$ and $A_{\tau,\mu}^-$, proving bi-linearity. It remains to be shown that Φ is in \mathcal{Z}_h . But this is clear since any element of the form given in [4, Fig. 33] can be horizontally “pulled through”. As such elements span the whole double triangle algebra, the claim is proven. \square

We need another graphical identity which refines [4, Lemma 6.2].

Lemma 4.5 *We have the identity in Fig. 28 for intertwiners in $\text{Hom}(\lambda'\bar{\mu}', \lambda\bar{\mu})$.*

$$\sum_a d_a \left[\text{Diagram 1} \right] = \delta_{\lambda,\lambda'} \delta_{\mu,\mu'} \frac{w}{d_{\lambda} d_{\mu}} \left[\text{Diagram 2} \right]$$

Figure 28: An identity in $\text{Hom}(\lambda'\bar{\mu}', \lambda\bar{\mu})$

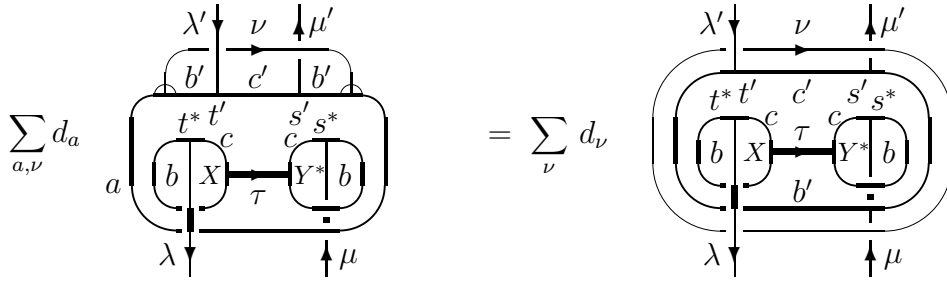

Figure 29: The identity in $\text{Hom}(\lambda'\bar{\mu}', \lambda\bar{\mu})$

Proof. Using the expansion of the identity (cf. [4, Lemma 4.3]) for the parallel wires a and b' on the top yields the left hand side of Fig. 29. We then slide around the trivalent vertices of the wire ν along the wire a so that they almost meet at the bottom of the picture. Turning around their small arcs yields a factor d_ν/d_a , and we can then see that the summation over a is just the expansion of the identity (cf. [4, Lemma 4.3]) which gives us two parallel wires b' and ν . This way we arrive at the right hand side of Fig. 29. Then we apply the expansion of the identity four times: First twice for the parallel wires b and b' on the bottom, yielding expansions over ρ and ρ' . Next we expand the parallel wires τ and b' in the middle lower part of the picture, resulting in a summation over a wire a' . Finally we expand the parallel wires c' and a' in the center of the picture, yielding a summation over a wire ρ'' . This gives us Fig. 30. Now we can pull the circle ν around the middle expansion ρ'' , just by

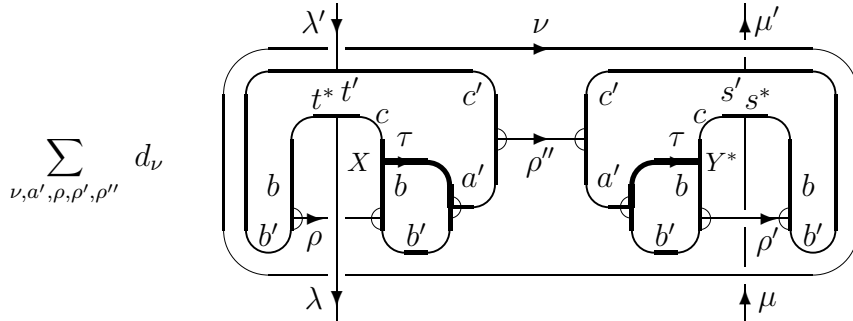

Figure 30: The identity in $\text{Hom}(\lambda'\bar{\mu}', \lambda\bar{\mu})$

virtue of the IBFE moves as well as the Yang-Baxter relation for thin wires. Due to the prefactor d_ν , the summation over ν yields exactly the orthogonality relation for a non-degenerate braiding (cf. [4, Fig. 20]), the “killing ring”. Therefore we obtain zero unless $\rho'' = \text{id}$, and our picture becomes disconnected yielding two intertwiners in $\text{Hom}(\lambda', \lambda)$ and $\text{Hom}(\bar{\mu}', \bar{\mu})$. Hence we obtain a factor $\delta_{\lambda, \lambda'} \delta_{\bar{\mu}, \bar{\mu}'}$, and the whole diagram represents a scalar. To compute the scalar, we can proceed exactly as in the

proof of [4, Lemma 6.2]: We go back to the original picture on the left hand side of Fig. 28 and put now $\lambda' = \lambda$ and $\mu' = \mu$. Then we close the wires λ and μ on the right which has to be compensated by a factor $d_\lambda^{-1}d_\mu^{-1}$. Next we open the wire a on the left and close it also on the right. Then the a loop can be pulled out and the summation over a gives the global index w ; we are left with the right hand side of Fig. 28. \square

Recall from [4, Thm. 6.8] that $\sum_{\lambda,\mu} q_{\lambda,\mu} = e_0$. The $\text{Hom}(a\bar{a}, d\bar{d})$ part of this relation gives us the graphical identity of Fig. 31. Inserting this in the middle of the

$$\sum_{b,c,\lambda,\mu} \frac{d_b d_c}{w^2} \left[\text{Diagram} \right] = \delta_{a,d} \frac{1}{d_a} \left[\text{Diagram} \right]$$

Figure 31: A graphical relation from $\sum_{\lambda,\mu} q_{\lambda,\mu} = e_0$

left hand side of Fig. 32, we find that this intertwiner is also a scalar which vanishes

$$\sum_a d_a \left[\text{Diagram} \right] = \delta_{\lambda,\lambda'} \delta_{\mu,\mu'} \delta_{\tau,\tau'} \frac{w}{d_\lambda d_\mu} \left[\text{Diagram} \right]$$

Figure 32: An identity in $\text{Hom}(\lambda' \bar{\mu}', \lambda \bar{\mu})$

unless $\lambda = \lambda'$ and $\mu = \mu'$. It can be evaluated in the same way, therefore we find a factor $\delta_{\tau,\tau'}$ and thus we arrive at

Corollary 4.6 *We have the identity in Fig. 32 for intertwiners in $\text{Hom}(\lambda' \bar{\mu}', \lambda \bar{\mu})$.*

Using now Fig. 9, we obtain from Corollary 4.6 and Lemma 4.4 the following

Corollary 4.7 *We have*

$$\begin{aligned} & |\varphi_1^{\tau,\lambda,+}\rangle\langle\varphi_2^{\tau,\lambda,+}| \otimes |\varphi_3^{\tau,\mu,-}\rangle\langle\varphi_4^{\tau,\mu,-}| *_v |\varphi_5^{\tau',\lambda',+}\rangle\langle\varphi_6^{\tau',\lambda',+}| \otimes |\varphi_7^{\tau',\mu',-}\rangle\langle\varphi_8^{\tau',\mu',-}| \\ &= \frac{\delta_{\tau,\tau'}\delta_{\lambda,\lambda'}\delta_{\mu,\mu'}}{wd_\tau} \langle\varphi_2^{\tau,\lambda,+}, \varphi_5^{\tau,\lambda,+}\rangle\langle\varphi_4^{\tau,\mu,-}, \varphi_7^{\tau,\mu,-}| \varphi_1^{\tau,\lambda,+}\rangle\langle\varphi_6^{\tau,\lambda,+}| \otimes |\varphi_3^{\tau,\mu,-}\rangle\langle\varphi_8^{\tau,\mu,-}|. \end{aligned} \quad (25)$$

Consequently, defining

$$E_{\tau,\lambda,\mu;i,k}^{j,l} = wd_\tau |u_i^{\tau,\lambda,+}\rangle\langle u_j^{\tau,\lambda,+}| \otimes |u_k^{\tau,\mu,-}\rangle\langle u_l^{\tau,\mu,-}| \quad (26)$$

gives a system of matrix units $\{E_{\tau,\lambda,\mu;i,k}^{j,l}\}_{\tau,\lambda,\mu,i,j,k,l}$ in $(\mathcal{Z}_h, *_v)$, i.e. we have

$$E_{\tau,\lambda,\mu;i,k}^{j,l} *_v E_{\tau',\lambda',\mu';i',k'}^{j',l'} = \delta_{\tau,\tau'}\delta_{\lambda,\lambda'}\delta_{\mu,\mu'}\delta_{j,i'}\delta_{l,k'} E_{\tau,\lambda,\mu;i,k}^{j',l'}. \quad (27)$$

We now define *chiral matrix units* by

$$\begin{aligned} E_{\tau,\lambda;i}^{+,j} &= \sum_\mu \sum_{k=1}^{\dim H_{\tau,\mu}^-} E_{\tau,\lambda,\mu;i,k}^{j,k}, \\ E_{\tau,\mu;k}^{-,l} &= \sum_\lambda \sum_{i=1}^{\dim H_{\tau,\lambda}^+} E_{\tau,\lambda,\mu;i,k}^{i,l}. \end{aligned} \quad (28)$$

Recall that $\mathcal{Z}_h^\pm \subset \mathcal{Z}_h$ are the chiral vertical subalgebras spanned by elements e_{β_\pm} with $\beta_\pm \in {}_M\mathcal{X}_M^\pm$.

Proposition 4.8 *We have $E_{\tau,\lambda;i}^{\pm,j} \in \mathcal{Z}_h^\pm$.*

Proof. We show $E_{\tau,\lambda;i}^{+,j} \in \mathcal{Z}_h^+$. The proof of $E_{\tau,\lambda;i}^{-,j} \in \mathcal{Z}_h^-$ is analogous. It follows from Lemma 3.11 that $E_{\tau,\lambda;i}^{+,j} = wd_\tau |u_i^{\tau,\lambda,+}\rangle\langle u_j^{\tau,\lambda,+}| \otimes I_\tau^-$. Therefore it suffices to show that $|\omega_{b',c',t',X'}^{\tau,\lambda,+}\rangle\langle\omega_{b,c,t,X}^{\tau,\lambda,+}| \otimes I_\tau^- \in \mathcal{Z}_h^+$. Such an element is given graphically in Fig. 33. If we

$$\sum_{a,b} \sum_{\beta \in {}_M\mathcal{X}_M^+} \frac{1}{w_+} \begin{array}{c} \begin{array}{c} a \\ | \\ t^* \quad c \\ | \quad | \\ \text{---} \text{---} \\ | \quad | \\ b \quad X \\ | \quad | \\ \text{---} \text{---} \\ | \quad | \\ \lambda \quad \beta \\ | \quad | \\ \text{---} \text{---} \\ | \quad | \\ b' \quad (X')^* \\ | \quad | \\ t' \quad c' \\ | \\ d \end{array} \end{array}$$

Figure 33: The element $|\omega_{b',c',t',X'}^{\tau,\lambda,+}\rangle\langle\omega_{b,c,t,X}^{\tau,\lambda,+}| \otimes I_\tau^-$

multiply horizontally with some $e_{\beta'}$ either from the left or from the right, then the resulting picture contains a part which corresponds to an intertwiner in $\text{Hom}(\beta', \beta)$ or $\text{Hom}(\beta, \beta')$, respectively. Hence this is zero unless $\beta' \in {}_M\mathcal{X}_M^+$. But \mathcal{Z}_h is spanned by elements e_β , $\beta \in {}_M\mathcal{X}_M$, and \mathcal{Z}_h^+ is the subspace spanned by those with $\beta \in {}_M\mathcal{X}_M^+$. As the e_β 's are horizontal projections, the claim follows. \square

Next we define *chiral vertical projectors* $q_{\tau,\lambda}^{\pm} \in \mathcal{Z}_h^{\pm}$ by

$$q_{\tau,\lambda}^{\pm} = \sum_{i=1}^{\dim H_{\tau,\lambda}^{\pm}} E_{\tau,\lambda;i}^{\pm}.$$

Hence

$$q_{\tau,\lambda}^{+} = wd_{\tau} I_{\tau,\lambda}^{+} \otimes I_{\tau}^{-} = \frac{\sqrt{d_{\tau}d_{\lambda}}}{w} \sum_{\xi} |\omega_{\xi}^{\tau,\lambda,+}\rangle \langle \omega_{\xi}^{\tau,\lambda,+}| \otimes I_{\tau}^{-},$$

and similarly

$$q_{\tau,\mu}^{-} = wd_{\tau} I_{\tau}^{+} \otimes I_{\tau,\mu}^{-} = \frac{\sqrt{d_{\tau}d_{\mu}}}{w} \sum_{\xi} I_{\tau}^{+} \otimes |\omega_{\xi}^{\mu,\lambda,-}\rangle \langle \omega_{\xi}^{\mu,\lambda,-}|.$$

Therefore $q_{\tau,\lambda}^{+}$ and $q_{\tau,\mu}^{-}$ can be displayed graphically by the left and right hand side of Fig. 34, respectively.

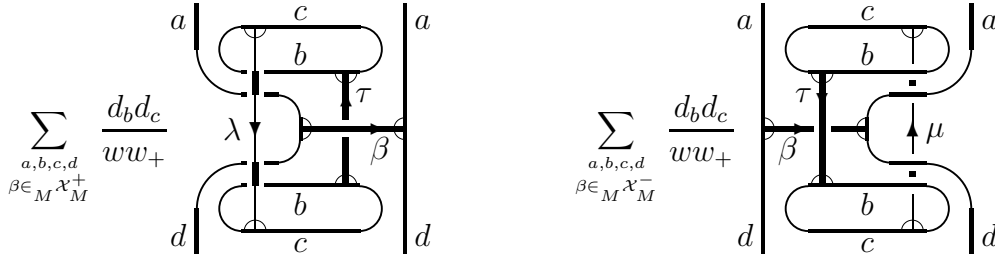

Figure 34: Chiral vertical projectors $q_{\tau,\lambda}^{+}$ and $q_{\tau,\mu}^{-}$

Lemma 4.9 *Whenever $\beta_{\pm} \in {}_M\mathcal{X}_M^{\pm}$ we have*

$$\begin{aligned} e_{\beta_+} *_v |\varphi_1^{\tau,\lambda,+}\rangle \langle \varphi_2^{\tau,\lambda,+}| \otimes |\varphi_3^{\tau,\mu,-}\rangle \langle \varphi_4^{\tau,\mu,-}| &= |\pi_{\tau,\lambda}^{+}(e_{\beta_+})\varphi_1^{\tau,\lambda,+}\rangle \langle \varphi_2^{\tau,\lambda,+}| \otimes |\varphi_3^{\tau,\mu,-}\rangle \langle \varphi_4^{\tau,\mu,-}|, \\ e_{\beta_-} *_v |\varphi_1^{\tau,\lambda,+}\rangle \langle \varphi_2^{\tau,\lambda,+}| \otimes |\varphi_3^{\tau,\mu,-}\rangle \langle \varphi_4^{\tau,\mu,-}| &= |\varphi_1^{\tau,\lambda,+}\rangle \langle \varphi_2^{\tau,\lambda,+}| \otimes |\pi_{\tau,\mu}^{-}(e_{\beta_-})\varphi_3^{\tau,\mu,-}\rangle \langle \varphi_4^{\tau,\mu,-}|. \end{aligned} \quad (29)$$

Proof. We only show the first relation; the proof for the second one is analogous. It suffices to show the relation for vectors $\omega_{b,c,t,X}^{\tau,\lambda,\pm}$. Then the vertical product

$$e_{\beta_+} *_v |\omega_{b_1,c_1,t_1,X_1}^{\tau,\lambda,+}\rangle \langle \omega_{b_2,c_2,t_2,X_2}^{\tau,\lambda,+}| \otimes |\omega_{b_3,c_3,t_3,X_3}^{\tau,\mu,-}\rangle \langle \omega_{b_4,c_4,t_4,X_4}^{\tau,\mu,-}|$$

is given graphically by the left hand side of Fig. 35. Since $\beta_+ \in {}_M\mathcal{X}_M^{+}$ admits relative braiding with α_{μ}^{-} , we can slide around the right trivalent vertex of the wire β_+ and apply the naturality move for the relative braiding to obtain the right hand side of

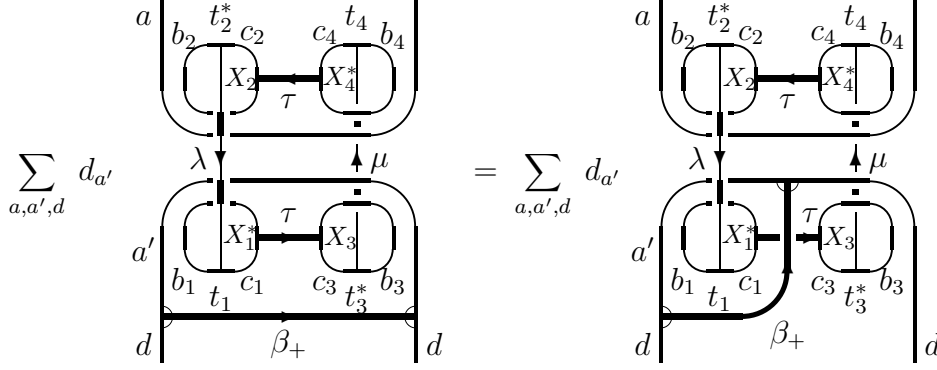

Figure 35: The action of e_{β_+} on $A_{\tau,\lambda}^+ \otimes A_{\tau,\mu}^-$

Fig. 35. In the lower left corner we now recognize the vector $\pi_{\tau,\lambda}^+(e_{\beta_+})\omega_{b_1,c_1,t_1,X_1}^{\tau,\lambda,+}$ of Fig. 17, hence the whole diagram represents the vector

$$|\pi_{\tau,\lambda}^+(e_{\beta_+})\omega_{b_1,c_1,t_1,X_1}^{\tau,\lambda,+}\langle\omega_{b_2,c_2,t_2,X_2}^{\tau,\lambda,+}|\otimes|\omega_{b_3,c_3,t_3,X_3}^{\tau,\mu,-}\rangle\langle\omega_{b_4,c_4,t_4,X_4}^{\tau,\mu,-}|\rangle,$$

yielding the statement. \square

From Lemma 4.9 we now obtain the following

Corollary 4.10 *We have*

$$E_{\tau,\lambda;i}^{\pm;j} *_v e_{\beta_{\pm}} *_v E_{\tau',\lambda';k}^{\pm;l} = \delta_{\tau,\tau'}\delta_{\lambda,\lambda'}\langle u_j^{\tau,\lambda,\pm}, \pi_{\tau,\lambda}^{\pm}(e_{\beta_{\pm}})u_k^{\tau,\lambda,\pm}\rangle E_{\tau,\lambda;i}^{\pm;l}. \quad (30)$$

In the coefficient on the right hand side of Eq. (30) we recognize the matrix elements of the chiral representations $\pi_{\tau,\lambda}^{\pm} : \mathcal{Z}_h^{\pm} \rightarrow B(H_{\tau,\lambda}^{\pm})$. We are now ready to prove the main result.

Theorem 4.11 *We have completeness*

$$\sum_{\tau \in_M \mathcal{X}_M^0} \sum_{\lambda, \mu \in_N \mathcal{X}_N} \sum_{i=1}^{\dim H_{\tau,\lambda}^+} \sum_{k=1}^{\dim H_{\tau,\mu}^-} E_{\tau,\lambda,\mu;i,k}^{i,k} = e_0. \quad (31)$$

Consequently the chiral vertical projectors $q_{\tau,\lambda}^{\pm}$ sum up to the multiplicative unit e_0 of $(\mathcal{Z}_h^{\pm}, *_v)$. Moreover, $q_{\tau,\lambda}^{\pm} = 0$ if and only if $b_{\tau,\lambda}^{\pm} = 0$, we have mutual orthogonality $q_{\tau,\lambda}^{\pm} *_v q_{\tau',\lambda'}^{\pm} = \delta_{\tau,\tau'}\delta_{\lambda,\lambda'}q_{\tau,\lambda}^{\pm}$ and $q_{\tau,\lambda}^{\pm}$ is a minimal central projection in $(\mathcal{Z}_h^{\pm}, *_v)$ whenever $b_{\tau,\lambda}^{\pm} \neq 0$. Thus the decomposition of the chiral centers into simple matrix algebras is given as

$$\mathcal{Z}_h^{\pm} \simeq \bigoplus_{\tau,\lambda} \text{Mat}(b_{\tau,\lambda}^{\pm}, \mathbb{C}). \quad (32)$$

Proof. All we have to show is the completeness relation Eq. (31); the rest is clear since then each e_β , $\beta \in {}_M\mathcal{X}_M^\pm$ can be expanded in the chiral matrix units. We have

$$\sum_{\tau,\lambda,\mu,i,k} E_{\tau,\lambda,\mu;i,k}^{i,k} = \sum_{\tau,\lambda,\mu,i,k} wd_\tau |u_i^{\tau,\lambda,+}\rangle \langle u_u^{\tau,\lambda,+}| \otimes |u_k^{\tau,\mu,-}\rangle \langle u_k^{\tau,\mu,-}| = \sum_\tau wd_\tau I_\tau^+ \otimes I_\tau^-,$$

and this is given graphically by the left hand side of Fig. 36. Looking at the middle

$$\sum_{\substack{\beta_+ \in {}_M\mathcal{X}_M^+ \\ \beta_- \in {}_M\mathcal{X}_M^-}} \sum_{\tau,a,b} \frac{wd_\tau}{w_+^2} \text{ (diagram) } = \sum_{\tau,\tau',a,b} \frac{wd_\tau}{w_+^2} \text{ (diagram)}$$

Figure 36: Completeness $\sum_{\tau,\lambda,\mu,i,k} E_{\tau,\lambda,\mu;i,k}^{i,k} = e_0$

part we observe that we obtain a factor δ_{β_+,β_-} , and therefore we only have a summation over $\tau' \in {}_M\mathcal{X}_M^0$. Then the middle bulb gives just the inner product of basis isometries, so that only one summation over internal fusion channels remains and we are left with the right hand side of Fig. 36. But now we obtain a factor $\delta_{\tau',0}$ and this yields exactly e_0 by virtue of the non-degeneracy of the ambichiral braiding, Theorem 4.2. \square

Corollary 4.12 *The total numbers of morphisms in the chiral systems ${}_M\mathcal{X}_M^\pm$ are given by $\text{tr}(\mathfrak{b}^\pm b^\pm) = \text{tr}(b^\pm \mathfrak{b}^\pm) = \sum_{\tau,\lambda} (b_{\tau,\lambda}^\pm)^2$.*

From Lemma 4.5 we conclude that $q_{\lambda,\mu} *_{\nu} E_{\tau,\lambda',\mu';i,k}^{j,l} = 0$ unless $\lambda = \lambda'$ and $\mu = \mu'$. Since $\sum_{\lambda,\mu} q_{\lambda,\mu} = e_0$ by [4, Thm. 6.8] we therefore obtain $E_{\tau,\lambda,\mu;i,k}^{j,l} = q_{\lambda,\mu} *_{\nu} E_{\tau,\lambda,\mu;i,k}^{j,l}$. On the other hand the completeness relation Eq. (31) yields similarly $q_{\lambda,\mu} = \sum_{\tau,i,k} q_{\lambda,\mu} *_{\nu} E_{\tau,\lambda,\mu;i,k}^{i,k}$. Hence we arrive at

Corollary 4.13 *The vertical projector $q_{\lambda,\mu}$ can be expanded as*

$$q_{\lambda,\mu} = \sum_{\tau \in {}_M\mathcal{X}_M^0} \sum_{i=1}^{\dim H_{\tau,\lambda}^+} \sum_{k=1}^{\dim H_{\tau,\mu}^-} E_{\tau,\lambda,\mu;i,k}^{i,k} \quad (33)$$

for any $\lambda, \mu \in {}_N\mathcal{X}_N$.

Note that this expansion corresponds exactly to the expansion of the modular invariant mass matrix in chiral branching coefficients in Eq. (16).

4.3 Representations of fusion rules and exponents

Recall that $\chi_\lambda(\nu) = Y_{\lambda,\nu}/d_\lambda = S_{\lambda,\nu}/S_{\lambda,0}$ are the evaluations of the statistics characters, $\lambda, \nu \in {}_N\mathcal{X}_N$. Similarly we have statistics characters for the ambichiral system: $\chi_\tau^{\text{ext}}(\tau') = Y_{\tau,\tau'}^{\text{ext}}/d_\tau = S_{\tau,\tau'}^{\text{ext}}/S_{\tau,0}^{\text{ext}}$. As derived in the general theory of α -induction [1, 3], sectors $[\alpha_\nu^\pm]$ commute with all subsectors of $[\alpha_\lambda^+][\alpha_\mu^-]$, thus with all sectors arising from ${}_M\mathcal{X}_M$ and in particular from ${}_M\mathcal{X}_M^\pm$. Consequently they must be scalar multiples of the identity in the irreducible representations of the corresponding fusion rules. In fact these scalars must be given by the evaluations of the chiral characters of the system ${}_N\mathcal{X}_N$ by virtue of the homomorphism property of α -induction (cf. [2]). We will now precisely determine the multiplicities of the occurring characters i.e. the multiplicities of the eigenvalues of the representation matrices.

Lemma 4.14 *For $\lambda, \mu, \nu, \rho \in {}_N\mathcal{X}_N$ and $\tau, \tau' \in {}_M\mathcal{X}_M^0$ we have vertical multiplication rules*

$$e_{\tau'} *_v p_\nu^+ *_v p_\rho^- *_v E_{\tau,\lambda,\mu;i,k}^{j,l} = d_{\tau'} \chi_\tau^{\text{ext}}(\tau') d_\nu \chi_\lambda(\nu) d_\rho \chi_\mu(\rho) E_{\tau,\lambda,\mu;i,k}^{j,l}. \quad (34)$$

Proof. It suffices to show the relation using elements given in Fig. 27 instead of matrix units $E_{\tau,\lambda,\mu;i,k}^{j,l}$. The product

$$p_\nu^+ *_v |\omega_{b_1,c_1,t_1,X_1}^{\tau,\lambda,+}\rangle \langle \omega_{b_2,c_2,t_2,X_2}^{\tau,\lambda,+}| \otimes |\omega_{b_3,c_3,t_3,X_3}^{\tau,\mu,-}\rangle \langle \omega_{b_4,c_4,t_4,X_4}^{\tau,\mu,-}|$$

is given graphically by the left hand side of Fig. 37. Here we have used the expansion

Figure 37: The action of p_ν^+ on $A_{\tau,\lambda}^+ \otimes A_{\tau,\mu}^-$

of the identity to replace parallel wires a', b_1 and a', b_3 by summations over wires ρ and ρ' . By virtue of the unitarity of braiding operators, the IBFE symmetries and the Yang-Baxter relation for thin wires, the wire α_ν^+ can now be pulled over the trivalent vertices and crossings to obtain the right hand side of Fig. 37. Here we have already resolved the summations over ρ, ρ' back to parallel wires a', b_1 and a', b_3 , respectively. Then we slide the trivalent vertices of the wire ν along the wire a' so that we obtain

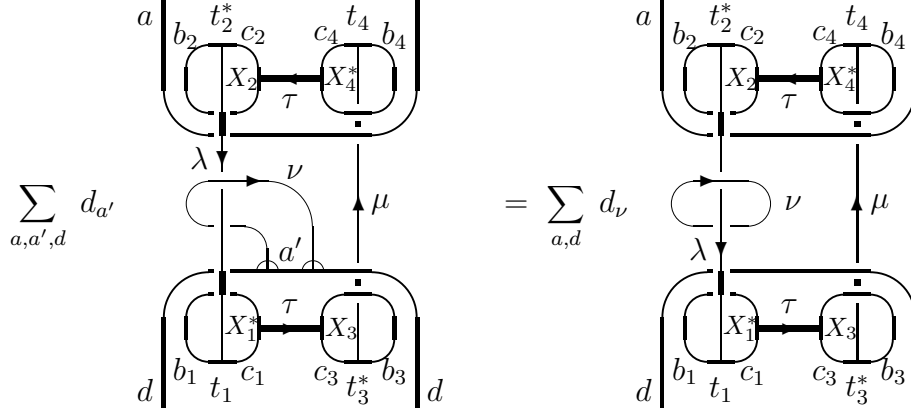

Figure 38: The action of p_ν^+ on $A_{\tau,\lambda}^+ \otimes A_{\tau,\mu}^-$

the left hand side of Fig. 38. Next we turn around the small arcs at the trivalent vertices of the wire ν , yielding a factor $d_\nu/d_{a'}$, so that the summation over a' is just identified as another expansion of the identity. Thus we arrive at the right hand side of Fig. 38. The circle ν around the wire λ is evaluated as the statistics character $\chi_\lambda(\nu)$ (cf. [4, Fig. 18]). Therefore the resulting diagram represents

$$d_\nu \chi_\lambda(\nu) |\omega_{b_1, c_1, t_1, X_1}^{\tau, \lambda, +}\rangle \langle \omega_{b_2, c_2, t_2, X_2}^{\tau, \lambda, +}| \otimes |\omega_{b_3, c_3, t_3, X_3}^{\tau, \mu, -}\rangle \langle \omega_{b_4, c_4, t_4, X_4}^{\tau, \mu, -}|.$$

The proof for p_ρ^- is analogous. Finally we consider

$$e_{\tau'} *_\nu |\omega_{b_1, c_1, t_1, X_1}^{\tau, \lambda, +}\rangle \langle \omega_{b_2, c_2, t_2, X_2}^{\tau, \lambda, +}| \otimes |\omega_{b_3, c_3, t_3, X_3}^{\tau, \mu, -}\rangle \langle \omega_{b_4, c_4, t_4, X_4}^{\tau, \mu, -}|$$

for $\tau' \in {}_M \mathcal{X}_M^0$. We proceed graphically as in the proof of Lemma 4.9, Fig. 35. But now we can slide around the trivalent vertices of the wire τ' and apply the naturality moves for the relative braiding on both sides as τ' is ambichiral. Therefore we obtain Fig. 39. Then the small arcs of the trivalent vertices of the wire τ' can again be turned around so that we obtain a factor $d_{\tau'}/d_{a'}$ and that the summation over a' yields just the expansion of the identity leaving us with parallel wires d and τ' . We conclude that the resulting diagram represents

$$d_{\tau'} \chi_\tau^{\text{ext}}(\tau') |\omega_{b_1, c_1, t_1, X_1}^{\tau, \lambda, +}\rangle \langle \omega_{b_2, c_2, t_2, X_2}^{\tau, \lambda, +}| \otimes |\omega_{b_3, c_3, t_3, X_3}^{\tau, \mu, -}\rangle \langle \omega_{b_4, c_4, t_4, X_4}^{\tau, \mu, -}|,$$

completing the proof. \square

Recall from [4, Sect. 6] that the irreducible representations $\pi_{\lambda,\mu}$ of the full center $(\mathcal{Z}_h, *_v)$ are labelled by pairs $\lambda, \mu \in {}_N \mathcal{X}_N$ with $Z_{\lambda,\mu} \neq 0$, and that they act on $Z_{\lambda,\mu}$ -dimensional representation spaces $H_{\lambda,\mu}$. From Corollary 4.10 and Corollary 4.13 we now obtain the following

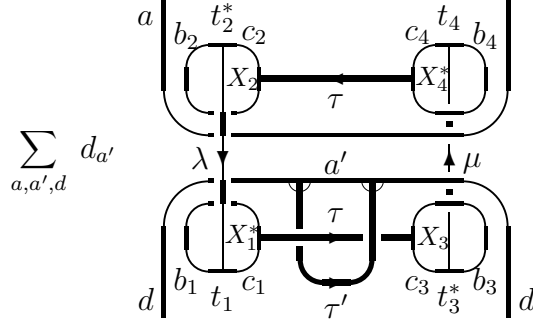

Figure 39: The action of $e_{\tau'}$ on $A_{\tau,\lambda}^+ \otimes A_{\tau,\mu}^-$

Corollary 4.15 For $\lambda, \mu, \nu, \rho \in {}_N\mathcal{X}_N$ and $\tau, \tau' \in {}_M\mathcal{X}_M^0$ we have

$$\begin{aligned} \pi_{\tau,\lambda}^\pm(e_{\tau'} *_{\nu} p_{\nu}^\pm) &= d_{\tau'} \chi_{\tau}^{\text{ext}}(\tau') d_{\nu} \chi_{\lambda}(\nu) \mathbf{1}_{H_{\tau,\lambda}^\pm}, \\ \pi_{\lambda,\mu}(p_{\nu}^+ *_{\nu} p_{\rho}^-) &= d_{\nu} \chi_{\lambda}(\nu) d_{\rho} \chi_{\mu}(\rho) \mathbf{1}_{H_{\lambda,\mu}}. \end{aligned} \quad (35)$$

Let $\Gamma_{\nu,\rho}$, $\nu, \rho \in {}_N\mathcal{X}_N$, denote the representation matrix of $[\alpha_{\nu}^+ \alpha_{\rho}^-]$ in the regular representation, i.e. the matrix elements are given by

$$\Gamma_{\nu,\rho;\beta}^{\beta'} = \langle \beta \alpha_{\nu}^+ \alpha_{\rho}^-, \beta' \rangle, \quad \beta, \beta' \in {}_M\mathcal{X}_M.$$

We can consider $\Gamma_{\nu,\rho}$ as the adjacency matrix of the simultaneous fusion graph of $[\alpha_{\nu}^+]$ and $[\alpha_{\rho}^-]$ on the M - M sectors. Similarly, let G_{ν} , $\nu \in {}_N\mathcal{X}_N$, denote the representation matrix of $[\alpha_{\nu}^\pm]$ in the representation $\varrho \circ \Phi$ on the M - N sectors (cf. [4, Thm. 6.12]), i.e. the matrix elements are given by

$$G_{\nu,a}^b = \langle a \alpha_{\nu}^\pm, b \rangle = \langle \nu a, b \rangle, \quad a, b \in {}_N\mathcal{X}_M,$$

where the second equality is due to [4, Prop. 3.1], and hence there is no distinction between $+$ and $-$. We can consider G_{ν} as the adjacency matrix of the fusion graph of $[\alpha_{\nu}^\pm]$ on the M - N sectors via left multiplication. Finally, let $\Gamma_{\tau',\nu}^\pm$, $\tau' \in {}_M\mathcal{X}_M^0$, $\nu \in {}_N\mathcal{X}_N$, denote the representation matrices of $[\tau' \alpha_{\nu}^\pm]$ in the chiral regular representations, i.e. the matrix elements are given by

$$\Gamma_{\tau',\nu;\beta}^{\pm;\beta'} = \langle \beta \tau' \alpha_{\nu}^\pm, \beta' \rangle, \quad \beta, \beta' \in {}_M\mathcal{X}_M^\pm.$$

We now arrive at our classification result.

Theorem 4.16 *The eigenvalues (“exponents”) of $\Gamma_{\nu,\rho}$, G_ν and $\Gamma_{\tau,\nu}^\pm$ for $\nu, \rho \in {}_N\mathcal{X}_N$, $\tau' \in {}_M\mathcal{X}_M^0$ are given by $\chi_\lambda(\nu)\chi_\mu(\rho)$, $\chi_\lambda(\nu)$, and $\chi_\tau^{\text{ext}}(\tau')\chi_\lambda(\nu)$, respectively, where $\lambda, \mu \in {}_N\mathcal{X}_N$ and $\tau \in {}_M\mathcal{X}_M^0$. They occur with the following multiplicities:*

1. $\text{mult}(\chi_\lambda(\nu)\chi_\mu(\rho)) = Z_{\lambda,\mu}^2$ for $\Gamma_{\nu,\rho}$,
2. $\text{mult}(\chi_\lambda(\nu)) = Z_{\lambda,\lambda}$ for G_ν ,
3. $\text{mult}(\chi_\tau^{\text{ext}}(\tau')\chi_\lambda(\nu)) = (b_{\tau,\lambda}^\pm)^2$ for $\Gamma_{\tau',\nu}^\pm$.

Proof. From the decomposition of the chiral centers in Theorem 4.11 it follows that the (left) regular representations π_{reg}^\pm of $(\mathcal{Z}_h^\pm, *_v)$ decompose into irreducibles as $\pi_{\text{reg}}^\pm = \bigoplus_{\tau,\lambda} b_{\tau,\lambda}^\pm \pi_{\tau,\lambda}^\pm$. It follows similarly from [4, Thm. 6.8] that the (left) regular representation π_{reg} of $(\mathcal{Z}_h, *_v)$ decomposes into irreducibles as $\pi_{\text{reg}} = \bigoplus_{\lambda,\mu} Z_{\lambda,\mu} \pi_{\lambda,\mu}$. Representations of the corresponding fusion rule algebras of M - M sectors are obtained by composition with the isomorphisms Φ mapping the M - M fusion rule algebra to $(\mathcal{Z}_h, *_v)$. It was established in [4, Thm. 6.12] that the representation $\varrho \circ \Phi$ of the full M - M fusion rule algebra obtained by left action multiplication on the M - N sectors decomposes into irreducibles as $\varrho \circ \Phi = \bigoplus_\lambda \pi_{\lambda,\lambda} \circ \Phi$. The claim follows now since Φ fulfills $\Phi([\beta]) = d_\beta^{-1} e_\beta$ by definition (cf. [4, Def. 4.5]) and $\Phi([\alpha_\nu^\pm]) = d_\nu^{-1} p_\nu^\pm$ by the identification theorem [4, Thm. 5.3]. \square

Recall that chiral locality implies for the branching coefficients $b_{\tau,\lambda} = b_{\tau,\lambda}^\pm$. The third statement of Theorem 4.16 was actually conjectured in [2, Subsect. 4.2] for conformal inclusions and (local) simple current extensions as a refinement of [2, Thm. 4.10], and such a connection between branching coefficients and dimensions of eigenspaces was first raised as a question in [42, Page 21] in the context of conformal inclusions.

5 The A-D-E classification of $SU(2)$ modular invariants

We now consider $SU(2)_k$ braided subfactors, i.e. we are dealing with subfactors $N \subset M$ where the system ${}_N\mathcal{X}_N$ is given by morphisms λ_j , $j = 0, 1, 2, \dots, k$, $\lambda_0 = \text{id}$, such that we have fusion rules $[\lambda_j][\lambda_{j'}] = \bigoplus_{j''} N_{j,j'}^{j''} [\lambda_{j''}]$ with

$$N_{j,j'}^{j''} = \begin{cases} 1 & |j - j'| \leq j'' \leq \min(j + j', 2k - j - j'), \\ 0 & \text{otherwise,} \end{cases} \quad j + j' + j'' \in 2\mathbb{Z}, \quad (36)$$

and that the statistics phases are given by

$$\omega_j = e^{2\pi i h_j}, \quad h_j = \frac{j(j+2)}{4k+8}$$

where $k = 1, 2, 3, \dots$ is the level. Therefore we are constructing modular invariants of the well-known representations of $SL(2; \mathbb{Z})$ arising from the $SU(2)$ level k WZW models.

5.1 The local inclusions: A_ℓ , $D_{2\ell}$, E_6 and E_8

We first recall the treatment of the local extensions, i.e. inclusions where the chiral locality condition is met. Namely, we consider “quantum field theoretical nets of subfactors” [26] $N(I) \subset M(I)$ on the punctured circle along the lines of [1, 2, 3]. Here these algebras live on a Hilbert space \mathcal{H} , and the restriction of the algebras $N(I)$ to the vacuum subspace \mathcal{H}_0 is of the form $\pi_0(L_I SU(2))''$ with π_0 being the level k vacuum representation of $LSU(2)$. We choose some interval I_o to obtain a single subfactor $N = N(I_o) \subset M(I_o) = M$. Then the system ${}_N\mathcal{X}_N = \{\lambda_j\}$ is given by the restrictions of DHR endomorphisms to the local algebras which arise from Wassermann’s [39] bimodule construction (see [2] for more explanation). The braiding is then given by the DHR statistics operators.

A rather trivial situation is clearly given by the trivial inclusion $N(I) = M(I) = \pi_0(L_I SU(2))''$ corresponding to $[\theta] = [\text{id}]$. We then obviously have $[\alpha_j^\pm] = [\lambda_j]$ for all j . (We denote $[\alpha_j^\pm] \equiv [\alpha_{\lambda_j}^\pm]$.) Therefore we just produce the trivial modular invariant $Z_{j,j'} = \delta_{j,j'}$, and the simultaneous fusion graph of $[\alpha_1^+]$ and $[\alpha_1^-]$ is nothing but one and the same graph A_{k+1} .

More interesting are the local simple current extensions (or “orbifold inclusions”) considered in [2, 3]. They occur at levels $k = 4\ell - 4$, $\ell = 2, 3, 4, \dots$, and are constructed by means of the simple current λ_k which satisfies $\lambda_k^2 = \text{id}$ and so that $[\theta] = [\text{id}] \oplus [\lambda_k]$. The structure of the full system ${}_M\mathcal{X}_M$, producing the $D_{2\ell}$ modular invariant, has been determined in [3, Subsect. 6.2]. The fusion graphs of $[\alpha_1^\pm]$ in the chiral systems were already identified in [2] as $D_{2\ell}$. Note that these are also the graphs with adjacency matrix G_1 , arising from the multiplication on M - N sectors. This is actually a general fact rather than a coincidence: Whenever the chiral locality condition $\varepsilon^+(\theta, \theta)\gamma(v) = \gamma(v)$ holds, then the set ${}_M\mathcal{X}_N$ consists of morphisms $\beta\iota$ where β varies in either ${}_M\mathcal{X}_M^+$ or equivalently in ${}_M\mathcal{X}_M^-$ due to [3, Lemma 4.1].

The exceptional invariants labelled by E_6 and E_8 arise from conformal inclusions $SU(2)_{10} \subset SO(5)_1$ and $SU(2)_{28} \subset (G_2)_1$, respectively, and have been treated in the nets of subfactors setting in [41, 2, 3]. The structure of the full systems has been completely determined in [3, Subsect. 6.1]. Note that in all these $SU(2)$ cases the simultaneous fusion graphs of $[\alpha_1^+]$ and $[\alpha_1^-]$ turn out [3, Figs. 2,5,8,9] (and similarly for the non-local examples Figs. 40 and 42 below) to coincide with Ocneanu’s diagrams for his “quantum symmetry on Coxeter graphs” [30]. The reason for this coincidence reflects the relation between α -induction and chiral generators for double triangle algebras [4, Thm. 5.3]. (See also the appendix of this paper for relations between our subfactors specified by canonical endomorphisms in a $SU(2)_k$ sector system and GHJ subfactors used in [30].)

5.2 The non-local simple current extensions: $D_{2\ell+1}$

We are now passing to the non-local examples which were not treated in [2, 3]. Without chiral locality we only have the inequality

$$\langle \alpha_\lambda^\pm, \alpha_\mu^\pm \rangle \leq \langle \theta\lambda, \mu \rangle \quad (37)$$

rather than the “main formula” [1, Thm. 3.9] because the “ \geq ” part of the proof of the main formula relies on the chiral locality condition. We remark that Eq. (37) is the analogue of Ocneanu’s “gap” argument used in his A-D-E setup of [30] but Eq. (37) is the suitable formulation for our more general setting which can in particular be used for non-local simple current extensions and other non-local inclusions of $LSU(n)$ theories. Moreover, we know that for the local cases, e.g. conformal inclusions and local simple current extensions of $LSU(n)$ as treated in [2, 3], we have exact equality and this makes concrete computations much easier.

As our first non-local example we consider the simple current extensions of $LSU(2)$ which, as we will see, produce the D_{odd} modular invariants. We start again with a net of local algebras for the $LSU(2)$ theories and construct nets of subfactors by simple current extensions along the lines of [2, Sect. 3] and [3, Subsect. 6.2]. Using the simple current $[\lambda_k]$ at level k satisfying the fusion rule $[\lambda_k^2] = [\text{id}]$, it was found in [2] that a local extension is only possible for $k \in 4\mathbb{Z}$. However, to proceed with the crossed product construction we only need the existence of a representative morphism λ_k of the sector $[\lambda_k]$ which satisfies $\lambda_k^2 = \text{id}$ as an endomorphism. By [36, Lemma 4.4], such a choice is possible if and only if the statistics phase ω_k of $[\lambda_k]$ fulfills $\omega_k^2 = 1$. As $\omega_k = e^{2\pi i h_k}$ by the conformal spin and statistics theorem [17] (see also [12, 11]) and since this conformal dimension is given by $h_k = k/4$, an extension can be constructed whenever the level is even. Now $k = 4\ell - 4$ is the local case producing $D_{2\ell}$, so here we are looking at $k = 4\ell - 2$ where $\ell = 2, 3, 4, \dots$. Because of Eq. (37) we find with $[\theta] = [\text{id}] \oplus [\lambda_k]$ that $\langle \alpha_j^\pm, \alpha_{j'}^\pm \rangle \leq \delta_{j,j'} + \delta_{j,k-j'}$ and hence all $[\alpha_j^\pm]$ ’s are forced to be irreducible except $[\alpha_{2\ell-1}^\pm]$ which may either be irreducible or decompose into two irreducibles. Moreover, we conclude $Z_{0,j} = \langle \text{id}, \alpha_j^- \rangle = \langle \theta, \lambda_j \rangle = 0$ for $j = 1, 2, \dots, k-1$. But we also obtain $Z_{0,k} = 0$ from $\omega_k = -1$ and $[T, Z] = 0$. Thus we have $Z_{0,j} = \delta_{0,j}$, and this forces a modular invariant mass matrix already to be a permutation matrix by Proposition 3.2. Now let us look at the M - N sectors which are subsectors of the $[\iota\lambda]$ ’s. By Frobenius reciprocity, we have in general

$$\langle \iota\lambda, \iota\mu \rangle = \langle \theta\lambda, \mu \rangle, \quad \lambda, \mu \in {}_N\mathcal{X}_N. \quad (38)$$

Therefore we find here $\langle \iota\lambda_j, \iota\lambda_{j'} \rangle = \delta_{j,j'} + \delta_{j,k-j'}$. This is enough to conclude that we have $2\ell+1$ irreducible M - N morphisms which can be given by $\iota\lambda_j$, $j = 0, 1, 2, \dots, 2\ell-2$, and \bar{b}, \bar{b}' with $[\iota\lambda_{2\ell-1}] = [\bar{b}] \oplus [\bar{b}']$. As a consequence, the matrix G_1 (i.e. the matrix G_ν for $\nu = \lambda_1$) is determined to be the adjacency matrix of $D_{2\ell+1}$. The exponents of $D_{2\ell+1}$ are known to be (see e.g. [16])

$$\text{Exp}(D_{2\ell+1}) = \{0, 2, 4, \dots, 4\ell - 2, 2\ell - 1\}$$

and all occur with multiplicity one. Theorem 4.16 forces the diagonal part of Z to be

$$Z_{j,j} = \begin{cases} 1 & j \in \text{Exp}(D_{2\ell+1}) \\ 0 & j \notin \text{Exp}(D_{2\ell+1}) \end{cases}.$$

By virtue of the classification of $SU(2)$ modular invariants [6, 22] we could now argue that Z must be the mass matrix labelled by $D_{2\ell+1}$, however, this is not necessary

since simple and general arguments already allow to construct Z directly. Namely, as Z is a permutation matrix we have $Z_{j,j'} = \delta_{j,\pi(j')}$ with π a permutation such that $\pi(j) = j$ for $j \in \text{Exp}(D_{2\ell+1})$ and $\pi(j) \neq j$ for $j \notin \text{Exp}(D_{2\ell+1})$. But since π defines a fusion rule automorphism we necessarily have $d_{\pi(j)} = d_j$. The values of the statistical dimensions for $SU(2)_k$ then allow only $\pi(j) = j$ or $\pi(j) = k - j$. We therefore have derived

$$Z_{j,j'} = \begin{cases} \delta_{j,j'} & j \in \text{Exp}(D_{2\ell+1}) \\ \delta_{j,k-j'} & j \notin \text{Exp}(D_{2\ell+1}) \end{cases}, \quad j, j' = 0, 1, 2, \dots, k.$$

This is the well-known mass matrix which was labelled by $D_{2\ell+1}$ in [5]. Note that we have ${}_M\mathcal{X}_M^\pm = {}_M\mathcal{X}_M$ here. We can now easily draw the simultaneous fusion graph of $[\alpha_1^+]$ and $[\alpha_1^-]$ which we display in Fig. 40 for D_5 and D_7 . As in [3], we draw straight

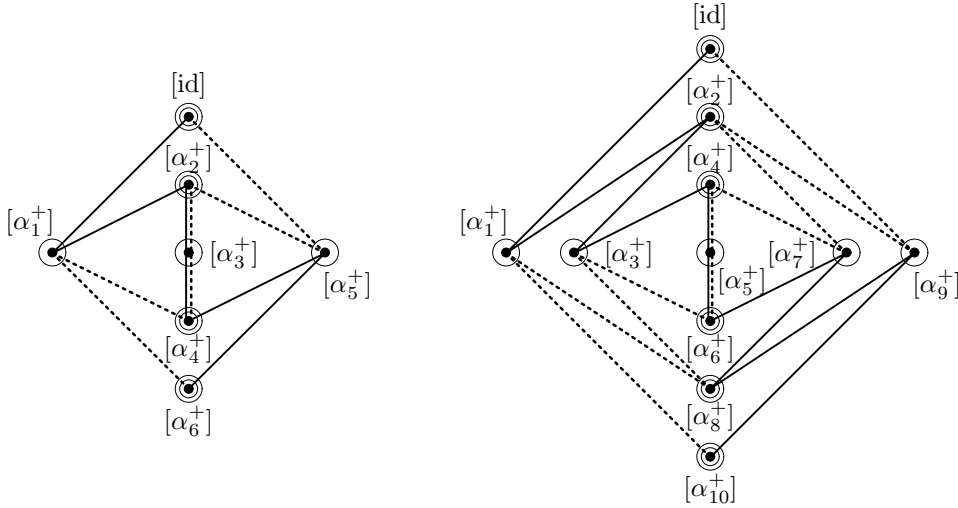

Figure 40: D_5 and D_7 : Fusion graphs of $[\alpha_1^+]$ and $[\alpha_1^-]$

lines for the fusion with $[\alpha_1^+]$ and dotted lines for the fusion with $[\alpha_1^-]$. (Note that $[\alpha_1^-] = [\alpha_{k-1}^+]$ here.) We also encircle even vertices by small circles and ambichiral (i.e. “marked”) vertices by large circles.

Note that we have $\langle \alpha_k^\pm, \gamma \rangle = \langle \alpha_k^\pm \iota, \iota \rangle = \langle \iota \lambda_k, \iota \rangle = \langle \lambda_k, \theta \rangle = 1$ by Frobenius reciprocity. Since $d_\gamma = d_\theta = 2$ we conclude $[\gamma] = [\text{id}] \oplus [\alpha_k^+]$. This shows that [3, Lemma 3.17] (and in turn [3, Cor. 3.18]) does not hold true without chiral locality.

5.3 E_7

We put $N = \pi_0(L_I SU(2))''$ where π_0 here denotes the level 16 vacuum representation of $LSU(2)$. We will show in the appendix (Lemma A.1) that there is an endomorphism $\theta \in \text{Mor}(N, N)$ at level $k = 16$ such that $[\theta] = [\text{id}] \oplus [\lambda_8] \oplus [\lambda_{16}]$ and which is the dual canonical endomorphism of some subfactor $N \subset M$. We will now show that this dual canonical endomorphism produces the E_7 modular invariant. From Eq. (38) we

obtain $\langle \iota\lambda_j, \iota\lambda_{j'} \rangle = \delta_{j,j'} + N_{8,j}^{j'} + \delta_{j,k-j'}$ where the fusion rules come from Eq. (36) with $k = 16$. With this it is straightforward to check that $[\iota\lambda_j]$, $j = 0, 1, 2, 3$, are irreducible and distinct M - N sectors. As $\langle \iota\lambda_4, \iota\lambda_4 \rangle = 2$ but $\langle \iota\lambda_4, \iota\lambda_j \rangle = 0$ for $j = 0, 1, 2, 3$ we conclude that $[\iota\lambda_4]$ decomposes into two new different sectors, $[\iota\lambda_4] = [\bar{b}] \oplus [\bar{b}']$. Similarly, $[\iota\lambda_5]$ decomposes into two sectors but here we have $[\iota\lambda_5] = [\iota\lambda_3] \oplus [\bar{c}]$ with only one new M - N sector $[\bar{c}]$ because $\langle \iota\lambda_5, \iota\lambda_3 \rangle = 1$. We have $\langle \iota\lambda_6, \iota\lambda_j \rangle = 1$ for $j = 2$ and $j = 4$, so $[\iota\lambda_6]$ has one subsector in common with $[\iota\lambda_4]$, say $[\bar{b}']$: $[\iota\lambda_6] = [\iota\lambda_2] \oplus [\bar{b}']$. We similarly find that the other $[\iota\lambda_j]$'s do not produce new M - N sectors. From $[\iota\lambda_5][\lambda_1] = [\iota\lambda_4] \oplus [\iota\lambda_6]$ and $[\iota\lambda_3][\lambda_1] = [\iota\lambda_2] \oplus [\iota\lambda_4]$ we now obtain $[\bar{c}][\lambda_1] = [\bar{b}]$. Thanks to Frobenius reciprocity we find also that $[\bar{c}]$ appears in the decomposition of $[\bar{b}][\lambda_1]$. This forces $[\bar{b}][\lambda_1] = [\iota\lambda_3] \oplus [\bar{c}]$ and $[\bar{b}'][\lambda_1] = [\iota\lambda_3]$. We therefore have determined the matrix G_1 to be the adjacency matrix of E_7 , see Fig. 41. The exponents of E_7

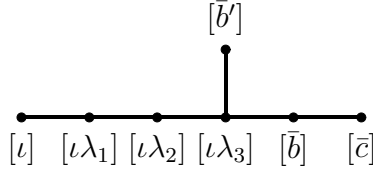

Figure 41: G_1 is the adjacency matrix of E_7

are given by $\text{Exp}(E_7) = \{0, 4, 6, 8, 10, 12, 16\}$ and all occur with multiplicity one. Theorem 4.16 forces the diagonal part of Z to be

$$Z_{j,j} = \begin{cases} 1 & j \in \text{Exp}(E_7) \\ 0 & j \notin \text{Exp}(E_7) \end{cases} .$$

By virtue of the classification of $SU(2)$ modular invariants [6, 22] we could now argue that Z must be the mass matrix labelled by E_7 but, as it is quite instructive, we prefer again to construct Z directly. From Eq. (37) we conclude that among the zero-column/row only $Z_{0,0}$, $Z_{0,8}$, $Z_{8,0}$, $Z_{0,16}$ and $Z_{16,0}$ can at most be one. But $[T, Z] = 0$ and $h_8 = 10/9$ forces $Z_{0,8} = Z_{8,0} = 0$. Now assume for contradiction that $Z_{0,16}$ (and hence $Z_{16,0}$) is zero. Then Z would be a permutation matrix by Proposition 3.2. As $Z_{1,1} = 0$ this would imply that $Z_{1,j} \neq 0$ for some $j \neq 0$, but this contradicts $[T, Z] = 0$ because $h_1 = 1/24$ and there is no other j with $h_j = 1/24 \pmod{\mathbb{Z}}$. Consequently $Z_{0,16} = Z_{16,0} = 1$. But the zero-column determines $\langle \alpha_j^+, \alpha_{j'}^+ \rangle$ since

$$\langle \alpha_j^+, \alpha_{j'}^+ \rangle = \langle \alpha_j^+ \alpha_{j'}^+, \text{id} \rangle = \sum_{j''} N_{j,j'}^{j''} Z_{j'',0} = \delta_{j,j'} + \delta_{j,16-j'} ,$$

and similarly the zero row determines $\langle \alpha_j^-, \alpha_{j'}^- \rangle = \delta_{j,j'} + \delta_{j,16-j'}$. This forces the fusion graphs of $[\alpha_1^\pm]$ in the chiral sector systems to be D_{10} , and then the whole fusion tables for the systems ${}_M \mathcal{X}_M^\pm$ are determined completely [19]. Moreover, we learn $w_+ = w/2$ from Proposition 3.1 and $w_0 = w_+/2$ from Theorem 4.2. This forces

the subsystem ${}_M\mathcal{X}_M^0 \subset {}_M\mathcal{X}_M^\pm$ to correspond to the even vertices of the D_{10} graph so that it can be given by ${}_M\mathcal{X}_M^0 = \{\text{id}, \alpha_2^+, \alpha_4^+, \alpha_6^+, \delta, \delta'\}$ with $\delta, \delta' \in \text{Mor}(M, M)$ such that $[\alpha_8^+] = [\delta] \oplus [\delta']$. The well-known Perron-Frobenius eigenvector of D_{10} tells us $d_\delta = d_{\delta'} = d_8/2$. Note that $[\alpha_8^+]$ and $[\alpha_8^-]$ have only one sector in common, say $[\delta]$, since $Z_{8,8} = 1$. On the other hand, $[\alpha_8^-]$ decomposes into two sectors, $[\alpha_8^-] = [\delta] \oplus [\delta'']$, which correspond to even vertices on the fusion graph D_{10} of $[\alpha_1^-]$, hence they are both ambichiral. The statistical dimensions then allow only $[\delta''] = [\alpha_2^+]$ and similarly $[\delta'] = [\alpha_2^-]$. Having now determined $b_{\tau,j}^\pm = \langle \tau, \alpha_j^\pm \rangle$ for each j and $\tau \in {}_M\mathcal{X}_M^0$ we can now read off the mass matrix Z from Eq. (16) and find that it is the E_7 one of [5]. We can also easily draw the simultaneous fusion graph of $[\alpha_1^+]$ and $[\alpha_1^-]$ in the entire M - M fusion rule algebra and we present it in Fig. 42. Again, we encircled even

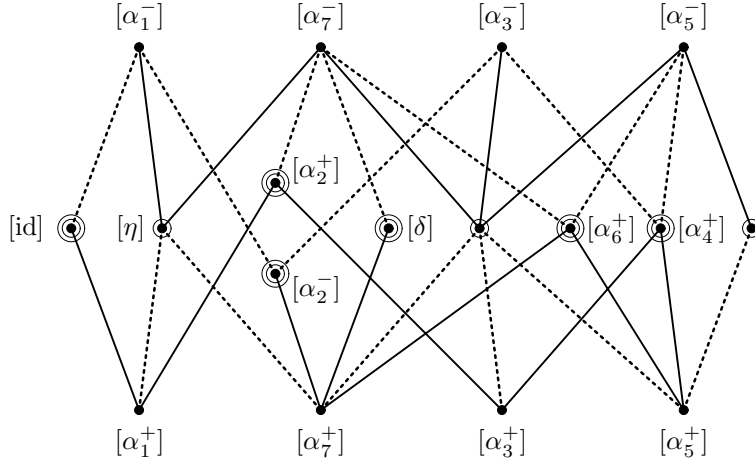

Figure 42: E_7 : Fusion graphs of $[\alpha_1^+]$ and $[\alpha_1^-]$

vertices by small and ambichiral (“marked”) vertices by large circles.

It is instructive to determine the canonical endomorphism sector $[\gamma]$. From

$$\langle \alpha_1^+ \alpha_1^-, \alpha_1^+ \alpha_1^- \rangle = \langle \alpha_1^+ \alpha_1^+, \alpha_1^- \alpha_1^- \rangle = Z_{0,0} + Z_{0,2} + Z_{2,0} + Z_{2,2} = 1$$

we conclude that $[\eta] = [\alpha_1^+ \alpha_1^-]$ is an irreducible sector which is a subsector of $[\gamma]$ since $\langle \alpha_1^+ \alpha_1^-, \gamma \rangle = \langle \lambda_1 \lambda_1, \theta \rangle = 1$ by Frobenius reciprocity. Similarly we find $\langle \alpha_8^\pm, \gamma \rangle = \langle \lambda_8, \theta \rangle = 1$ which implies that $[\delta]$ is a subsector of $[\gamma]$. As $\langle \gamma, \gamma \rangle = \langle \theta, \theta \rangle = 3$ by [3, Lemma 3.16], we conclude $[\gamma] = [\text{id}] \oplus [\eta] \oplus [\delta]$.

5.4 A-D-E and representations of the Verlinde fusion rules

We have realized all $SU(2)$ modular invariants from subfactors. All canonical endomorphisms of these subfactors have only subsectors $[\lambda_j]$ with j even. Therefore Eq. (38) transfers the two-coloring of the $SU(2)$ sectors to the M - N sectors: Set the colour of an M - N sector $[\bar{a}]$ to be 0 (respectively 1) whenever it is a subsector of $[\iota \lambda_j]$

with j even (respectively odd). Consequently the matrix G_1 is the adjacency matrix of a bi-colourable graph. Moreover, G_1 is irreducible (i.e. the graph is connected) since λ_1 generates the whole N - N system. We also have $\|G_1\| = d_1 < 2$. Hence G_1 must be one of the A-D-E cases (see e.g. [16]). As Theorem 4.16 forces the diagonal entries $Z_{j,j}$ of the modular invariant mass matrix to be given as the multiplicities of the eigenvalues $\chi_j(1)$ of G_1 , our results explain why they happen to be the multiplicities of the Coxeter exponents of A-D-E Dynkin diagrams. We summarize several data about the sector systems for the $SU(2)$ modular invariants in Table 1. The

Invariant $\leftrightarrow G_1$	Level k	$\#_M \mathcal{X}_M$	$\#_M \mathcal{X}_N$	$\#_M \mathcal{X}_M^\pm$	$\#_M \mathcal{X}_M^0$	$\Gamma_{0,1}^\pm$	$\Gamma_{\tau_{\text{gen}},0}^\pm$
$A_\ell, \ell \geq 2$	$\ell - 1$	ℓ	ℓ	ℓ	ℓ	A_ℓ	A_ℓ
$D_{2\ell}, \ell \geq 2$	$4\ell - 4$	4ℓ	2ℓ	2ℓ	$\ell + 1$	$D_{2\ell}$	$D_{2\ell}^{\text{even}}$
$D_{2\ell+1}, \ell \geq 2$	$4\ell - 2$	$4\ell - 1$	$2\ell + 1$	$4\ell - 1$	$4\ell - 1$	$A_{4\ell-1}$	$A_{4\ell-1}$
E_6	10	12	6	6	3	E_6	A_3
E_7	16	17	7	10	6	D_{10}	D_{10}^{even}
E_8	28	32	8	8	2	E_8	A_4^{even}

Table 1: The A-D-E classification of $SU(2)$ modular invariants

last column has the following meaning. We chose an element $\tau_{\text{gen}} \in {}_M \mathcal{X}_M^0$ such that $[\tau_{\text{gen}}]$ is a subsector of $[\alpha_j^+]$ for the smallest possible $j \geq 1$. This element turns out to generate the whole ambichiral system. For example, in the E_7 case we take $\tau_{\text{gen}} = \alpha_2^+$. The (adjacency matrix of the) fusion graph of $[\tau_{\text{gen}}]$ in the ambichiral system is given in the last column.

Let us finally explain how the representation $\varrho \circ \Phi$ which arises from left multiplication of M - M sectors on the M - N sectors is related to a fusion rule algebra for (some) type I invariants. Let V_1 be the adjacency matrix of one of the Dynkin diagrams. Then there is a unitary matrix which diagonalizes V_1 , i.e. $\psi^* V_1 \psi$ is the diagonal matrix giving the eigenvalues corresponding to the Coxeter exponents. In fact, Di Francesco and Zuber [7, 8] built up a whole family of matrices V_λ with non-negative integer entries (λ running over the spins for the time being), diagonalized simultaneously by ψ and providing a representation of the Verlinde fusion rules, $V_\lambda V_\mu = \sum_\nu N_{\lambda,\mu}^\nu V_\nu$. Among the column vectors ψ_m , m labelling the eigenvalues including multiplicities of the diagram at hand, there is necessarily a Perron-Frobenius eigenvector ψ_0 of V_1 with only strictly positive entries: $\psi_{a,0} > 0$ for all vertices a of the diagram. It turned out, actually first noticed in [32], that for D_{even} , E_6 and E_8 , which label the type I modular invariants, it was possible to choose² ψ such that also

²The matrix ψ is determined up to a rotation in each multiplicity space of the eigenvalues

all $\psi_{0,m} > 0$, here $a = 0$ refers to the extremal vertex, and that it has a remarkable property: Plugged in a Verlinde type formula,

$$N_{a,b}^c = \sum_m \frac{\psi_{a,m}}{\psi_{0,m}} \psi_{b,m} \psi_{c,m}^*, \quad (39)$$

it yields non-negative integers $N_{a,b}^c$ which could be interpreted as structure constants of a fusion algebra, the “graph algebra”. This procedure worked analogously for the graphs Di Francesco and Zuber [7, 8] associated to some $SU(n)$ type I modular invariants essentially by matching the spectra with the diagonal entries of the mass matrices, whereas for type II invariants, in particular D_{odd} and E_7 for $SU(2)$, it did not work. For instance, for E_7 there appeared some negative structure constants.

These observations find a natural explanation in our setting. The graphs Di Francesco and Zuber associated empirically to modular invariants are recognized as the fusion graphs of $[\alpha_\lambda^+]$ obtained by multiplication from the left on the M - N sectors (or, equivalently, from the right on N - M sectors), i.e. $V_\lambda = G_\lambda$. A priori, there is no reason why a matrix ψ which diagonalizes the adjacency matrix of the graph(s) should produce non-negative integer structure constants because the N - M morphisms alone do not form a fusion algebra on their own: You cannot multiply two N - M morphisms, and there is no identity. However, whenever the chiral locality condition holds, then there is a canonical bijection between the N - M system and either chiral induced system [3, Lemma 4.1]: Any N - M sector $[a]$, $a \in {}_N\mathcal{X}_M$, is of the form $[a] = [\bar{\iota}\beta]$, where either $\beta \in {}_M\mathcal{X}_M^+$ or $\beta \in {}_M\mathcal{X}_M^-$. This implies that, in the notation of Subsect. 4.3, we have equality of matrices $V_\nu = G_\nu = \Gamma_{0,\nu}^+ = \Gamma_{0,\nu}^-$. Recall that chiral locality implies by Proposition 3.4 that $b_{\tau\lambda}^+ = b_{\tau,\lambda}^- = b_{\tau,\lambda}$, with restriction coefficients $b_{\tau,\lambda} = \langle \bar{\iota}\tau\iota, \lambda \rangle$, and that then the modular invariant is of type I: $Z_{\lambda,\mu} = \sum_\tau b_{\tau,\lambda} b_{\tau,\mu}$. In fact, we read off from Theorem 4.16 that the eigenvalue $\chi_\lambda(\nu)$ of $G_\nu = \Gamma_{0,\nu}^\pm$ appears with multiplicity $Z_{\lambda,\lambda} = \sum_\tau b_{\tau,\lambda}^2$. Now let N_β be the fusion matrix of $\beta \in {}_M\mathcal{X}_M^+$ in the chiral system, i.e. $(N_\beta)_{\beta',\beta''} = N_{\beta',\beta}^{\beta''} = \langle \beta'\beta, \beta'' \rangle$, $\beta', \beta'' \in {}_M\mathcal{X}_M^+$. Then we have $\Gamma_{0,\nu}^+ = \sum_\beta \langle \beta, \alpha_\nu^+ \rangle N_\beta$. Consequently, as long as the chiral system is commutative³, there is always a unitary matrix ψ which diagonalizes the fusion matrices N_β simultaneously, and in turn their linear combinations $\Gamma_{0,\nu}^+$. Evaluation of the zero-component of $N_\beta \psi_m = \gamma_m(\beta) \psi_m$, with $\gamma_m(\beta)$ some eigenvalue, yields $\psi_{\beta,m} = \gamma_m(\beta) \psi_{0,m}$, hence vanishing $\psi_{0,m}$ would contradict unitarity of ψ , and thus one can choose $\psi_{0,m} > 0$. (See e.g. [23] or [10, Sect. 8.7] for such computations.) Consequently the eigenvalues are given as $\gamma_m(\beta) = \psi_{\beta,m} / \psi_{0,m}$, so that the structure constants are in fact given by Eq. (39), using the bijection ${}_N\mathcal{X}_M \ni a \leftrightarrow \beta \in {}_M\mathcal{X}_M^+$.

Type II modular invariants necessarily violate the chiral locality condition, and without chiral locality the bijection between N - M system and the chiral systems in

(exponents). So it is only D_{even} where one needs to make a choice to produce non-negative integers.

³The “first” example of a non-commutative chiral system is the type I invariant coming from the conformal inclusion $SU(4)_4 \in SO(15)_1$ [41, 2]. In fact, that there are difficulties to obtain non-negativity of structure constants from a Verlinde type formula was noticed in [33]. A general analysis taking care of non-commutative chiral systems as well as a discussion of “marked vertices” can be found in [2].

general breaks down. For $SU(2)$ this can nicely be seen in Table 1: For the D_{odd} invariants, $G_1 = D_{2\ell+1}$, we see that G_1 is in fact different from $\Gamma_{0,1}^\pm = A_{4\ell-1}$. Similarly we have $\Gamma_{0,1}^\pm = D_{10}$ for $G_1 = E_7$.

6 More examples

6.1 Conformal inclusions of $SU(3)$

We discuss two more examples arising from conformal inclusions of $SU(3)$. The structure of the chiral systems has been determined in [41, 2]. Combining the methods and results in [41, 1, 2, 3], and [4], we can compute the full systems ${}_M\mathcal{X}_M$ in examples along the lines of [3, Sect. 6].

The first example is the conformal inclusion $SU(3)_3 \subset SO(8)_1$. The associated modular invariant is

$$Z_{\mathcal{D}^{(6)}} = |\chi_{(0,0)} + \chi_{(3,0)} + \chi_{(3,3)}|^2 + 3|\chi_{(2,1)}|^2,$$

and was labelled by the orbifold graph $\mathcal{D}^{(6)}$ in [8]. In fact, this conformal inclusion can also be treated as a local simple current extension, similar to the D_4 case for $SU(2)$. We omit the straightforward calculations which determine the fusion structure of the full system ${}_M\mathcal{X}_M$. We present the simultaneous fusion graph of $[\alpha_{(1,0)}^+]$ (straight lines) and $[\alpha_{(1,0)}^-]$ (dotted lines) in Fig. 43. We have encircled the marked vertices by big circles and the colour zero vertices by small vertices. (Because the vacuum block has only colour zero contributions, the full system inherits the three colouring of the $SU(3)_3$ system ${}_N\mathcal{X}_N$ here.) As the modular invariant contains an entry 3 we conclude by [4, Cor. 6.9] that the entire M - M fusion rule algebra is non-commutative. The colour zero part has 12 vertices which all correspond to simple sectors. Therefore they form a closed subsystem corresponding to a group. This group must contain a $\mathbb{Z}_2 \times \mathbb{Z}_2$ subgroup corresponding to the $SO(8)_1$ fusion rules of the marked vertices. Note that any M - M sector of non-zero colour is a product $[\alpha_{(1,0)}^\pm][\beta]$ or $[\alpha_{(1,1)}^\pm][\beta]$ with $\beta \in {}_M\mathcal{X}_M$ a colour zero morphism. Since $[\alpha_{(1,0)}^\pm]$ and $[\alpha_{(1,1)}^\pm]$ commute with each M - M sector by [3, Lemma 3.20], they will be scalars in any irreducible representation of the M - M fusion rules. Consequently, the representation $\pi_{(2,1),(2,1)}$ of dimension $Z_{(2,1),(2,1)} = 3$ will remain irreducible upon restriction to the group of colour zero sectors. Therefore its group dual is forced to consist of one 3-dimensional and three scalar representations, and in turn we identify the group of colour zero sectors to be the tetrahedral group $A_4 = (\mathbb{Z}_2 \times \mathbb{Z}_2) \rtimes \mathbb{Z}_3$.

The next example is a conformal inclusion $SU(3)_5 \subset SU(6)_1$. The associated modular invariant, labelled as $\mathcal{E}^{(8)}$, is given by

$$\begin{aligned} Z_{\mathcal{E}^{(8)}} = & |\chi_{(0,0)} + \chi_{(4,2)}|^2 + |\chi_{(2,0)} + \chi_{(5,3)}|^2 + |\chi_{(2,2)} + \chi_{(5,2)}|^2 \\ & + |\chi_{(3,0)} + \chi_{(3,3)}|^2 + |\chi_{(3,1)} + \chi_{(5,5)}|^2 + |\chi_{(3,2)} + \chi_{(5,0)}|^2. \end{aligned}$$

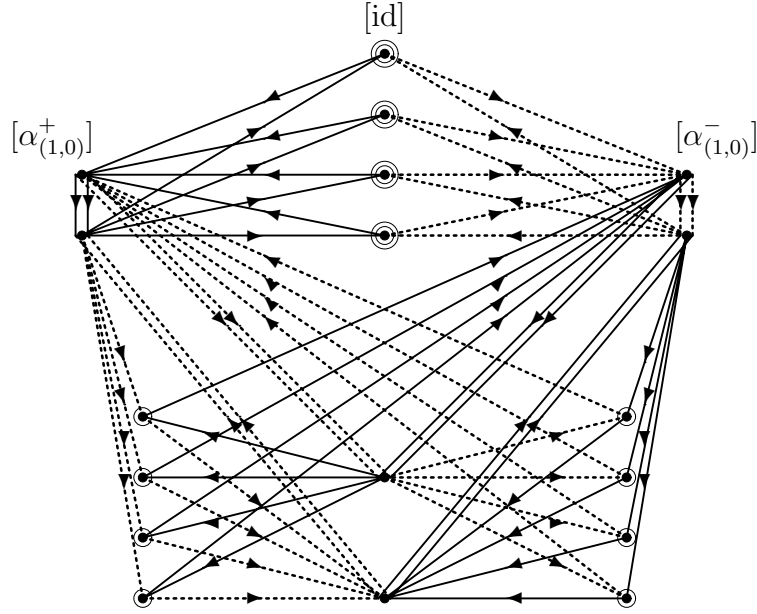

Figure 43: $SU(3)_3 \subset SO(8)_1, \mathcal{D}^{(6)}$: Fusion graph of $[\alpha_{(1,0)}^+]$ and $[\alpha_{(1,0)}^-]$

Again, we omit the straightforward calculations which determine the structure of the full system ${}_M\mathcal{X}_M$ and present the simultaneous fusion graph of $[\alpha_{(1,0)}^+]$ (thick lines) and $[\alpha_{(1,0)}^-]$ (thin lines) in Fig. 44.

6.2 Trivial invariants from non-trivial inclusions and degenerate braidings

We will now give examples of non-trivial inclusions $N \subset M$ which however produce the trivial modular invariants $Z_{\lambda,\mu} = \langle \alpha_\lambda^+, \alpha_\mu^- \rangle = \delta_{\lambda,\mu}$. This is clearly only possible if the chiral locality condition is violated because chiral locality implies the formula $\langle \alpha_\lambda^\pm, \alpha_\mu^\pm \rangle = \langle \theta\lambda, \mu \rangle$, as derived in [1, Thm. 3.9]; hence, if $[\mu]$ is a non-trivial subsector of $[\theta]$, then $Z_{0,\mu} = \langle \text{id}, \alpha_\mu^- \rangle = \langle \alpha_{\text{id}}^-, \alpha_\mu^- \rangle$ must be non-zero. Consequently a “local extension” can only exist if there exists a non-trivial mass matrix Z commuting with the S- and T-matrices arising from the braiding.

Consider the situation that our subfactor $N \subset M$ subject to Assumptions 2.3 and 2.4 is given as a Jones basic extension $\rho(N) \subset N \subset M$ with $\rho \in \Sigma({}_N\mathcal{X}_N)$. Note that then $\theta = \rho\bar{\rho}$. We also have $\bar{\iota}(M) = \rho(N)$, hence $\phi = \rho^{-1} \circ \bar{\iota}$ is an isomorphism from M onto N with inverse $\phi^{-1} = \bar{\iota}^{-1} \circ \rho$. Using $\varepsilon^\pm(\lambda, \theta) = \rho(\varepsilon^\pm(\lambda, \bar{\rho}))\varepsilon^\pm(\lambda, \rho)$ one finds that the α -induction formula can be written as $\alpha_\lambda^\pm = \text{Ad}(u_\pm) \circ \phi^{-1} \circ \lambda \circ \phi$ with unitaries $u_\pm = \phi^{-1}(\varepsilon^\pm(\lambda, \bar{\rho})) \in M$. Then the map $\text{Hom}(\lambda, \mu) \rightarrow \text{Hom}(\alpha_\lambda^+, \alpha_\mu^\pm)$, $t \mapsto u_\pm \phi^{-1}(t)u_\pm^*$ is an isomorphism, $\lambda, \mu \in \Sigma({}_N\mathcal{X}_N)$. Consequently, for $\lambda, \mu \in {}_N\mathcal{X}_N$

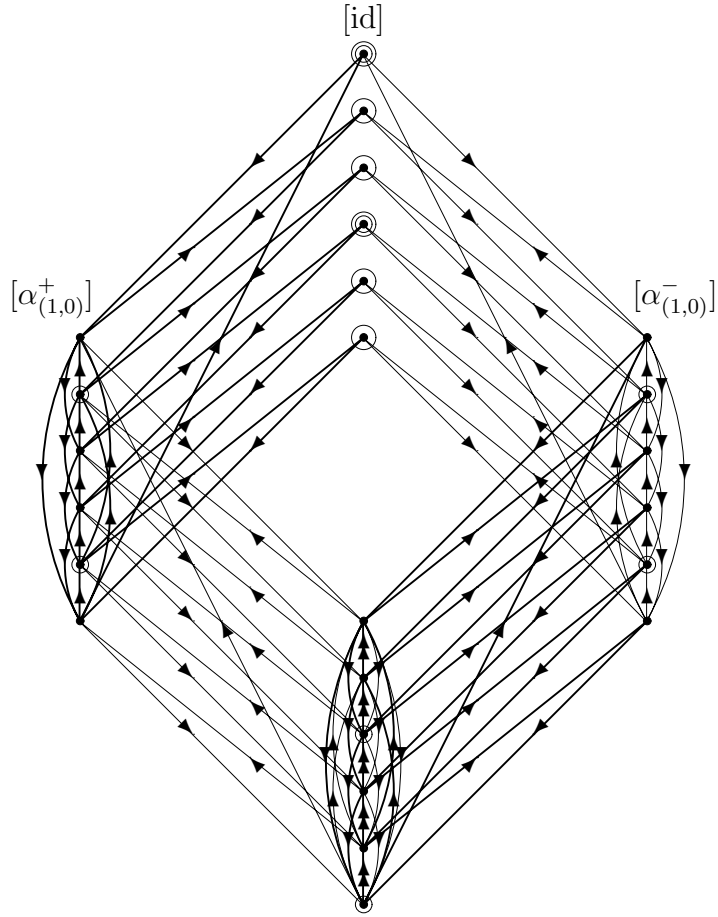

Figure 44: $SU(3)_5 \subset SU(6)_1$, $\mathcal{E}^{(8)}$: Fusion graph of $[\alpha_{(1,0)}^+]$ and $[\alpha_{(1,0)}^-]$

all α_λ^\pm are irreducible and pairwise inequivalent so that $Z_{\lambda,\mu} = \delta_{\lambda,\mu}$.

Examples related to conformal field theory are therefore Jones extensions of $\rho(N) \subset N$ with ρ an endomorphism of a $SU(n)_k$ system as introduced before. Such inclusions $N \subset M$ are in fact (isomorphic to) Jones-Wassermann subfactors. Specializing to the case $n = 2$ and choosing $\rho = \lambda_1$, the spin one endomorphism, this is by [39] and [34, Cor. 6.4] a (type III₁) Jones subfactor [20] with principal graph A_{k+1} . Note that then $[\theta] = [\lambda_1^2] = [\text{id}] \oplus [\lambda_2]$ produces the trivial modular invariant. Instead of the full system labelled by all spins $j = 0, 1, \dots, k$ we may also make the “minimal choice” ${}_N\mathcal{X}_N = \{\lambda_j : j \text{ even}\}$. The braiding of this system is no longer non-degenerate so that there is no representation of the modular group arising from the braiding. This example also shows that the generating property of α -induction [4, Thm. 5.10] can even hold without non-degeneracy in particular cases, because ${}_M\mathcal{X}_M^\pm = {}_M\mathcal{X}_M$ thanks to Proposition 3.2. But note that the braiding is neither com-

pletely degenerate. The complete degeneracy means that any monodromy operator is trivial. However, for $k > 2$ the self-monodromy of the morphism λ_2 has always the non-trivial eigenvalue $e^{-8\pi i/k+2}$ corresponding to the fusion rule $N_{2,2}^0 = 1$ and due to $h_2 = 2/k + 2$, cf. [4, Eq. (11)]. As in turn also the monodromy of λ_2 and θ is non-trivial, this shows, maybe not surprisingly, that [1, Prop. 3.23] does not hold without the chiral locality assumption.

Finally we consider a completely degenerate example, arising from the classical DHR theory [9]. The subfactor $N \subset M$ is given by a local subfactor $A(\mathcal{O}) \subset F(\mathcal{O})$, arising from a net of inclusions of observable algebras in field algebras over the Minkowski space, arising from a compact gauge group G . Then $A(\mathcal{O})$ is given as the fixed point algebra under the outer action of the gauge group, $A(\mathcal{O}) = F(\mathcal{O})^G$. The canonical endomorphism sector $[\theta]$ decomposes as $[\theta] = \bigoplus d_\lambda[\lambda]$, where the sum runs over DHR endomorphisms λ labelled by the irreducible representations of G . (By abuse of notation we use the same symbol λ for the morphisms as for the elements of the group dual \hat{G} .) These DHR morphisms obey the fusion rules of \hat{G} so that the statistical dimension d_λ is in particular the dimension of the group representation. We assume that G is finite and choose the system ${}_N\mathcal{X}_N$ to be given by all the λ 's. Moreover, we assume that the field net is purely bosonic, i.e. local, so that we have $\omega_\lambda = 1$ for all λ . It is straightforward to check that then (see [4, Subsect. 2.2]) $w = \sum_\lambda d_\lambda^2 = \#G$, $S_{\lambda,\mu} = (\#G)^{-1}d_\lambda d_\mu$ and $T_{\lambda,\mu} = \delta_{\lambda,\mu}$. Note that the S-matrix is a rank one projection here. Due to locality of the field net, the chiral locality condition⁴ holds here, and consequently $\langle \alpha_\lambda^\pm, \alpha_\mu^\pm \rangle = \langle \theta\lambda, \mu \rangle = d_\lambda d_\mu$, which forces $[\alpha_\lambda^\pm] = d_\lambda[\text{id}]$. (This just reflects the fact that in the DHR case α -induction is just the obvious extension of the implementation by a Hilbert space of isometries which is certainly inner in M .) Hence we find $Z_{\lambda,\mu} = d_\lambda d_\mu$, i.e. $Z = wS$. Note that $\text{tr}(Z) = \#G$ and $\text{tr}(Z^*Z) = (\#G)^2$. However, we have $\#_N\mathcal{X}_M = 1$ as $[\iota\lambda] = [\alpha_\lambda^\pm \iota] = d_\lambda[\iota]$ and $\#_M\mathcal{X}_M = \#G$ since similarly $[\iota\lambda\bar{\iota}] = d_\lambda[\gamma]$, and since it is known [25] that γ decomposes into automorphisms corresponding to the group elements. So we observe that, due to the degeneracy, the generating property of α -induction [4, Thm. 5.10] does not hold, neither the countings of [4, Cors. 6.10 and 6.13] are true here; we have an over-counting by $\#G$.

A The dual canonical endomorphism for E_7

Lemma A.1 *For $SU(2)$ at level $k = 16$, there is an endomorphism $\theta \in \text{Mor}(N, N)$ such that $[\theta] = [\text{id}] \oplus [\lambda_8] \oplus [\lambda_{16}]$ and which is the dual canonical endomorphism of a subfactor $N \subset M$.*

Proof. First note that the subfactor $\lambda_1(N) \subset N$ arising from the loop group construction for $SU(2)_{16}$ in [39] is isomorphic to $P \otimes R \subset Q \otimes R$, where Q is a hyperfinite II_1 factor, $P \subset Q$ is the Jones subfactor [20] with principal graph A_{17} ,

⁴We admit that the name “chiral locality condition” does not make much sense when using the Minkowski space instead of a compactified light cone axis S^1 .

and R is an injective III_1 factor, by [34, Cor. 6.4]. This shows that the subfactor $\theta(N) \subset N$ for $[\theta] = [\text{id}] \oplus [\lambda_8] \oplus [\lambda_{16}]$ is isomorphic to $pP \otimes R \subset p(Q_{15})p \otimes R$, where $P \subset Q \subset Q_1 \subset Q_2 \subset \dots$ is the Jones tower of $P \subset Q$ and p is a sum of three minimal projections in $P' \cap Q_{15}$ corresponding to $\text{id}, \lambda_8, \lambda_{16}$. It is thus enough to prove that the subfactor $pP \subset p(Q_{15})p$ is a basic construction of some subfactor.

We recall a construction in [16, Sect. 4.5]. Let Γ be one of the Dynkin diagrams of type A, D, E. Let A_0 be an abelian von Neumann algebra \mathbf{C}^n and A_1 be a finite dimensional von Neumann algebra containing A_0 such that the Bratteli diagram for $A_0 \subset A_1$ is Γ . Using the unique normalized Markov trace on A_1 , we repeat basic constructions to get a tower $A_0 \subset A_1 \subset A_2 \subset \dots$ with the Jones projections e_1, e_2, e_3, \dots . Let \tilde{C} be the GNS-completion of $\bigcup_{m \geq 0} A_m$ with respect to the trace and \tilde{B} its von Neumann subalgebra generated by $\{e_m\}_{m \geq 1}$. We have $\tilde{B}' \cap \tilde{C} = A_0$ by Skau's lemma. For a projection $q \in A_0$, we have a subfactor $B = q\tilde{B} \subset q\tilde{C}q = C$, which is called a Goodman-de la Harpe-Jones (GHJ) subfactor.

Let Γ be E_7 and q be the projection corresponding to the vertex of E_7 with minimum Perron-Frobenius eigenvector entry. We study the subfactor $B \subset C$ in this setting. Set $B_m = q\langle e_1, e_2, \dots, e_{m-1} \rangle$, $C_m = qA_mq$. The sequence $\{B_m \subset C_m\}_m$ is a periodic sequence of commuting squares of period 2 in the sense of Wenzl [40]. For a sufficiently large m , we can make a basic construction $B_m \subset C_m \subset D_m$ so that $B \subset C \subset D = \bigvee_m D_m$ is also a basic construction. We can extend the definition of D_m to small m so that the sequences $\{B_m \subset C_m \subset D_m\}_m$ is a periodic sequence of commuting squares of period 2. For a sufficiently large m , the graph of the Bratteli diagram for $B_{2m} \subset C_{2m}$ stays the same and the graph for $C_{2m} \subset D_{2m}$ is its reflection. This graph can be computed as in Fig. 45 in an elementary way (see e.g. [31], [10, Examples 11.25, 11.71]), so we also have the graph for $B_{2m} \subset D_{2m}$, and we see that D_0 is $\mathbf{C} \oplus \mathbf{C} \oplus \mathbf{C}$ and the three minimal projections in D_0 correspond to the 0th, 8th, and 16th vertices of A_{17} . (The graph in Fig. 45 is actually the principal graph

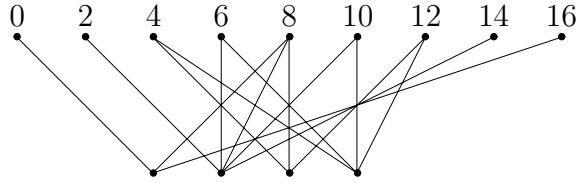

Figure 45: The Bratteli diagram

of $B \subset C$ by [31], but this is not important here.) Then we see that the Bratteli diagram for the sequence $\{D_m\}_m$ starts with these three vertices and we have the graph A_{17} or a part of it as the Bratteli diagram at each step, as in Fig. 46. Each algebra B_m is generated by the Jones projections of the sequence $\{D_m\}_m$.

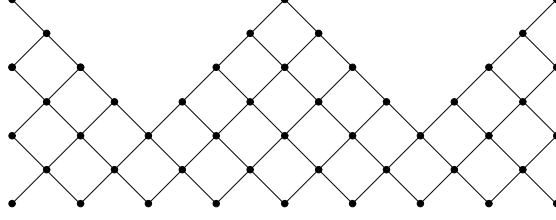

Figure 46: The Bratteli diagram for $\{D_m\}_m$

Similarly, if we choose A_{17} as Γ and q be the projection corresponding to the first vertex of A_{17} , we get a periodic sequence $\{E_m \subset F_m\}_m$ of commuting squares. (Note that we start the numbering of the vertices of A_{17} with 0.) It is well-known that the resulting subfactor $E = \bigvee_m E_m \subset \bigvee_m F_m = F$ is the Jones subfactor [20] with principal graph A_{17} . We make basic constructions of $E_m \subset F_m$ for 15 times in the same way as above and get a periodic sequence $\{E_m \subset G_m\}_m$ of commuting squares. Let \tilde{q} be a sum of three minimal projections corresponding to the 0th, 8th, and 16th vertices of A_{17} in G_0 . Setting $\tilde{E}_m = \tilde{q}E_m$ and $\tilde{G}_m = qG_mq$, we get a periodic sequence of commuting squares $\{\tilde{E}_m \subset \tilde{G}_m\}_m$ such that the resulting subfactor $\bigvee_m \tilde{E}_m \subset \bigvee_m \tilde{G}_m$ is isomorphic to $pP \subset p(Q_{15})p$ defined in the first paragraph.

Now we see that the Bratteli diagram of the sequence $\{\tilde{G}_m\}_m$ is the same as the one for $\{D_m\}_m$ as in Fig. 46 and each algebra \tilde{E}_m is generated by the Jones projections for the sequence $\{\tilde{G}_m\}_m$. This shows that the two periodic sequences of commuting squares $\{B_m \subset D_m\}_m$ and $\{\tilde{E}_m \subset \tilde{G}_m\}_m$ are isomorphic. Thus the resulting subfactors $B \subset D$ and $pP \subset p(Q_{15})p$ are also isomorphic. Since the subfactor $B \subset D$ is a basic construction of $B \subset C$, we conclude that the subfactor $pP \subset p(Q_{15})p$ is also a basic construction of some subfactor, as desired. \square

Remark A.2 With a different choice of q corresponding to another end vertex of E_7 , we can also prove that $[\lambda_0] \oplus [\lambda_6] \oplus [\lambda_{10}] \oplus [\lambda_{16}]$ for $SU(2)_{16}$ gives a dual canonical endomorphism in a similar way. This also produces the E_7 modular invariant.

We can also choose D_5 as Γ and q to be a minimal central projection corresponding to one of the two tail vertices of D_5 , and then the same method as in the above proof shows that $[\lambda_0] \oplus [\lambda_4]$ for $SU(2)_6$ gives a dual canonical endomorphism. One can check that this produces the D_5 modular invariant.

In Lemma A.1 above, we have used the construction of the GHJ-subfactor for E_7 . We can also apply the same construction to E_6 , E_8 as in [16]. Note that the principal graph [31] of the GHJ-subfactor with $\Gamma = E_6$ [resp. E_8] for the choice of q corresponding to the vertex with the lowest Perron-Frobenius eigenvector entry is the

same as the principal graph, Fig. 3 [resp. Fig. 6] in [3], of the subfactor arising from the conformal inclusion $SU(2)_{10} \subset SO(5)_1$ [resp. $SU(2)_{28} \subset (G_2)_1$] studied in [3, Sect. 6.1]. It is then natural to expect that these subfactor are indeed isomorphic (after tensoring a common injective factor of type III₁). For the E₆ case, a combinatorial unpublished argument of Rehren shows that we have only two paragroups for the principal graph in [3, Fig. 3] and these produce two mutually dual subfactors. This implies the desired isomorphism of our two subfactors by [34, Cor. 6.4], but it seems very hard to obtain a similar argument for the E₈ case. Here we prove the desired isomorphism for both cases of E₆ and E₈.

Proposition A.3 *The subfactor arising from the conformal inclusion $SU(2)_{10} \subset SO(5)_1$ [resp. $SU(2)_{28} \subset (G_2)_1$] is isomorphic to the GHJ subfactor constructed as above for E₆ [resp. E₈] tensored with a common injective factor of type III₁.*

Proof. By [34, Cor. 6.4], it is enough to prove that the two subfactors have the same higher relative commutants.

Let $N \subset M$ be the subfactor arising from the conformal inclusion and ι the inclusion map $N \hookrightarrow M$. We label N - N morphisms as $\lambda_0 = \text{id}, \lambda_1, \dots, \lambda_k$, where $k = 10$ or $k = 28$. We set the finite dimensional C^* -algebras $A_{m,l}$, $m \geq 0, l \geq -1$, to be as follows. (For $l = -1$, m starts at 1.)

$$\left\{ \begin{array}{ll} \text{Hom}(\theta^{m/2}(\lambda_1 \bar{\lambda}_1)^{l/2}, \theta^{m/2}(\lambda_1 \bar{\lambda}_1)^{l/2}), & (m : \text{even}, l : \text{even}), \\ \text{Hom}(\theta^{m/2}(\lambda_1 \bar{\lambda}_1)^{(l-1)/2} \lambda_1, \theta^{m/2}(\lambda_1 \bar{\lambda}_1)^{(l-1)/2} \lambda_1), & (m : \text{even}, l : \text{odd}), \\ \text{Hom}(\iota \theta^{(m-1)/2}(\lambda_1 \bar{\lambda}_1)^{l/2}, \iota \theta^{(m-1)/2}(\lambda_1 \bar{\lambda}_1)^{l/2}), & (m : \text{odd}, l : \text{even}), \\ \text{Hom}(\iota \theta^{(m-1)/2}(\lambda_1 \bar{\lambda}_1)^{(l-1)/2} \lambda_1, \iota \theta^{(m-1)/2}(\lambda_1 \bar{\lambda}_1)^{(l-1)/2} \lambda_1), & (m : \text{odd}, l : \text{odd}), \\ \text{Hom}(\bar{\iota} \gamma^{(m-2)/2}, \bar{\iota} \gamma^{(m-2)/2}), & (m : \text{even}, l = -1), \\ \text{Hom}(\gamma^{(m-1)/2}, \gamma^{(m-1)/2}), & (m : \text{odd}, l = -1). \end{array} \right.$$

We then naturally have inclusions $A_{m,l} \subset A_{m,l+1}$, and similarly embeddings $\iota : A_{2m,l} \hookrightarrow A_{2m+1,l}$ as well as $\bar{\iota} : A_{2m-1,l} \hookrightarrow A_{2m,l}$. With these, we have a double sequence of commuting squares. Note that the sequence $\{A_{m,l}\}_{m,l \geq 0}$ is a usual double sequence of string algebras as in [29, Chapter II] (cf. [10, Sect. 11.3]) and we now have an extra sequence $\{A_{m,-1}\}_{m \geq 1}$ here.

Set $A_{m,\infty}$ to be the GNS-completions of $\bigcup_{l=0}^{\infty} A_{m,l}$ with respect to the trace. Then we have the Jones tower as

$$A_{0,\infty} \subset A_{1,\infty} \subset A_{2,\infty} \subset \dots$$

The Bratteli diagram of $\{A_{0,l}\}_l$ is given by reflections of the Dynkin diagram of type A₁₁ or A₂₉, so the algebra $A_{0,\infty}$ is generated by the Jones projections. The Bratteli diagram of $\{A_{1,l}\}_l$ is given by reflections of the Dynkin diagram of type E₆ or E₈ since we know the fusion graph of λ_1 on the M - N sectors, so the subfactor $A_{0,\infty} \subset A_{1,\infty}$ is isomorphic to the GHJ-subfactor. Then we next show that the higher relative commutants of this subfactor are given as

$$\begin{aligned} A'_{0,\infty} \cap A_{m,\infty} &= A_{m,0}, \\ A'_{1,\infty} \cap A_{m,\infty} &= A_{m,-1}, \end{aligned}$$

which are also the higher relative commutants of $N \subset M$ from the above definition, so the proof will be complete.

The definition of $\{A_{m,l}\}_{m,l}$ shows that $A_{2m,0}$ and $A_{0,l}$ commute. Then Ocneanu's compactness argument [29, Sect. II.6] (cf. [10, Thm. 11.15]) or Wenzl's dimension estimate [40, Thm. 1.6] gives $A_{m,0} = A'_{0,\infty} \cap A_{m,\infty}$. We similarly have $A_{m,-1} \subset A'_{1,\infty} \cap A_{m,\infty}$. In general, we have

$$\dim(A'_{0,\infty} \cap A_{2m+1,\infty}) = \dim(A'_{1,\infty} \cap A_{2m+2,\infty}),$$

so that we can compute

$$\begin{aligned} \dim \operatorname{Hom}(\iota\theta^m, \iota\theta^m) &= \dim A_{2m+1,0} = \dim(A'_{0,\infty} \cap A_{2m+1,\infty}) \\ &= \dim(A'_{1,\infty} \cap A_{2m+2,\infty}) \geq \dim A_{2m+2,-1} = \dim \operatorname{Hom}(\bar{\iota}\gamma^m, \bar{\iota}\gamma^m) \\ &= \dim \operatorname{Hom}(\iota\theta^m, \iota\theta^m), \end{aligned}$$

which shows equality $A_{2m+2,-1} = A'_{1,\infty} \cap A_{2m+2,\infty}$. We then have

$$A'_{1,\infty} \cap A_{2m+1,\infty} \subset (A'_{1,\infty} \cap A_{2m+2,\infty}) \cap A_{2m+1,\infty} = A_{2m+2,-1} \cap A_{2m+1,\infty} = A_{2m+1,-1},$$

which completes the proof. \square

Proposition A.3 implies in particular that the graph in [3, Fig. 7] is also the dual principal graph of the GHJ-subfactor arising from E_8 .

Acknowledgment. Part of this work was done during visits of the third author to the University of Wales Swansea and the University of Wales Cardiff, visits of all the three to Università di Roma "Tor Vergata" and visits of the first two authors to the Australian National University, Canberra, the University of Melbourne, the University of Newcastle, the University of Tokyo and the Research Institute for Mathematical Sciences, Kyoto. We are indebted to R. Longo, L. Zsido, J.E. Roberts, D.W. Robinson, P.A. Pearce, I. Raeburn, T. Miwa, H. Araki and these institutions for their hospitality. We gratefully acknowledge the financial support of the Australian National University, CNR (Italy), EPSRC (U.K.), the EU TMR Network in Non-Commutative Geometry, Grant-in-Aid for Scientific Research, Ministry of Education (Japan), the Kanagawa Academy of Science and Technology Research Grants, the Università di Roma "Tor Vergata", University of Tokyo, and the University of Wales.

References

- [1] J. Böckenhauer, D.E. Evans, *Modular invariants, graphs and α -induction for nets of subfactors. I*, Commun. Math. Phys. **197** (1998) 361–386
- [2] J. Böckenhauer, D.E. Evans, *Modular invariants, graphs and α -induction for nets of subfactors. II*, Commun. Math. Phys. **200** (1999) 57–103
- [3] J. Böckenhauer, D.E. Evans, *Modular invariants, graphs and α -induction for nets of subfactors. III*, Commun. Math. Phys. **205** (1999) 183–228

- [4] J. Böckenhauer, D.E. Evans, Y. Kawahigashi, *On α -induction, chiral generators and modular invariants for subfactors*, preprint, math.OA/9904109
- [5] A. Cappelli, C. Itzykson, J.-B. Zuber, *Modular invariant partition functions in two dimensions*, Nucl. Phys. **B280** (1987) 445–465
- [6] A. Cappelli, C. Itzykson, J.-B. Zuber, *The A-D-E classification of minimal and $A_1^{(1)}$ conformal invariant theories*, Commun. Math. Phys. **113** (1987) 1–26
- [7] P. Di Francesco, J.-B. Zuber, *$SU(N)$ lattice integrable models associated with graphs*, Nucl. Phys. **B338** (1990) 602–646
- [8] P. Di Francesco, J.-B. Zuber, *$SU(N)$ lattice integrable models and modular invariance*, in: S. Randjbar et al (eds.), *Recent Developments in Conformal Field Theories*, Singapore: World Scientific 1990, pp. 179–215
- [9] S. Doplicher, R. Haag, J.E. Roberts, *Fields, observables and gauge transformations. I*, Commun. Math. Phys. **13** (1969), 1–23.
- [10] D.E. Evans, Y. Kawahigashi, *Quantum symmetries on operator algebras*, Oxford: Oxford University Press, 1998
- [11] K. Fredenhagen, K.-H. Rehren, B. Schroer, *Superselection sectors with braid group statistics and exchange algebras. II*, Rev. Math. Phys. **Special issue** (1992) 113–157
- [12] J. Fröhlich, F. Gabbiani, *Braid statistics in local quantum theory*, Rev. Math. Phys. **2** (1990) 251–353
- [13] T. Gannon, *WZW commutants, lattices and level-one partition functions*, Nucl. Phys. **B396** (1993) 708–736
- [14] T. Gannon, *The classification of affine $SU(3)$ modular invariants*, Commun. Math. Phys. **161** (1994) 233–264
- [15] B. Gato-Rivera, A.N. Schellekens, *Complete classification of simple current automorphisms*, Nucl. Phys. **B353** (1991) 519–537
- [16] F. Goodman, P. de la Harpe, V.F.R. Jones, *Coxeter graphs and towers of algebras*, MSRI publications 14, Berlin: Springer, 1989
- [17] D. Guido, R. Longo, *The conformal spin and statistics theorem*, Commun. Math. Phys. **181** (1996) 11–35
- [18] C. Itzykson, *From the harmonic oscillator to the A-D-E classification of conformal models*, Adv. Stud. in Pure Math. **19** (1989) 287–346
- [19] M. Izumi, *Application of fusion rules to classification of subfactors*, Publ. RIMS, Kyoto Univ. **27** (1991) 953–994
- [20] V.F.R. Jones, *Index for subfactors*, Invent. Math. **72** (1983) 1–25
- [21] V.G. Kac, *Infinite dimensional Lie algebras*, 3rd edition, Cambridge: Cambridge University Press, 1990
- [22] A. Kato, *Classification of modular invariant partition functions in two dimensions*, Modern Phys. Lett **A 2** (1987) 585–600
- [23] T. Kawai, *On the structure of fusion rule algebras*, Phys. Lett. **B217** (1989) 247–251
- [24] H. Kosaki, *Extension of Jones theory on index to arbitrary factors*, J. Funct. Anal. **66** (1986) 123–140
- [25] R. Longo, *A Duality for Hopf algebras and for subfactors I*, Commun. Math. Phys. **159** (1994) 133–150

- [26] R. Longo, K.-H. Rehren, *Nets of subfactors*, Rev. Math. Phys. **7** (1995) 567–597
- [27] G. Moore, N. Seiberg, *Naturality in conformal field theory*, Nucl. Phys. **B313** (1989) 16–40
- [28] W. Nahm, *Lie group exponents and $SU(2)$ current algebras*, Commun. Math. Phys. **118** (1988) 171–176
- [29] A. Ocneanu, *Quantum symmetry, differential geometry of finite graphs and classification of subfactors*, Univ. of Tokyo Seminary Notes 45, 1991 (Notes recorded by Y. Kawahigashi)
- [30] A. Ocneanu, *Paths on Coxeter diagrams: From Platonic solids and singularities to minimal models and subfactors* (Notes recorded by S. Goto), in preparation.
- [31] S. Okamoto, *Invariants for subfactors arising from Coxeter graphs*, in: H. Araki et al. (eds.), *Current Topics in Operator Algebras*, Singapore: World Scientific 1991, pp. 84–103.
- [32] V. Pasquier, *Etiology of IRF models*, Commun. Math. Phys. **118** (1988) 355–364
- [33] V.B. Petkova, J.-B. Zuber, *From CFT to graphs*, Nucl. Phys. **B463** (1996) 161–193
- [34] S. Popa, *Classification of subfactors and of their endomorphisms*, CBMS Regional Conference Series, Am. Math. Soc. **86** (1995)
- [35] K.-H. Rehren, *Braid group statistics and their superselection rules*, in: D. Kastler (ed.), *The algebraic theory of superselection sectors*, Palermo 1989, Singapore: World Scientific 1990, pp. 333–355
- [36] K.-H. Rehren, *Space-time fields and exchange fields*, Commun. Math. Phys. **132** (1990) 461–483
- [37] K.-H. Rehren, *Chiral observables and modular invariants*, preprint, hep-th/9903262
- [38] A.N. Schellekens, S. Yankielowicz, *Extended chiral algebras and modular invariant partition functions*, Nucl. Phys. **B327** (1989) 673–703
- [39] A. Wassermann, *Operator algebras and conformal field theory III: Fusion of positive energy representations of $SU(N)$ using bounded operators*, Invent. Math. **133** (1998) 467–538
- [40] H. Wenzl, *Hecke algebras of type A_n and subfactors*, Invent. Math. **92** (1988) 345–383
- [41] F. Xu, *New braided endomorphisms from conformal inclusions*, Commun. Math. Phys. **192** (1998) 347–403
- [42] F. Xu, *Applications of braided endomorphisms from conformal inclusions*, Internat. Math. Research Notices, (1998) 5–23, see also the erratum to Theorem 3.4 (1) on page 437 of the same volume